

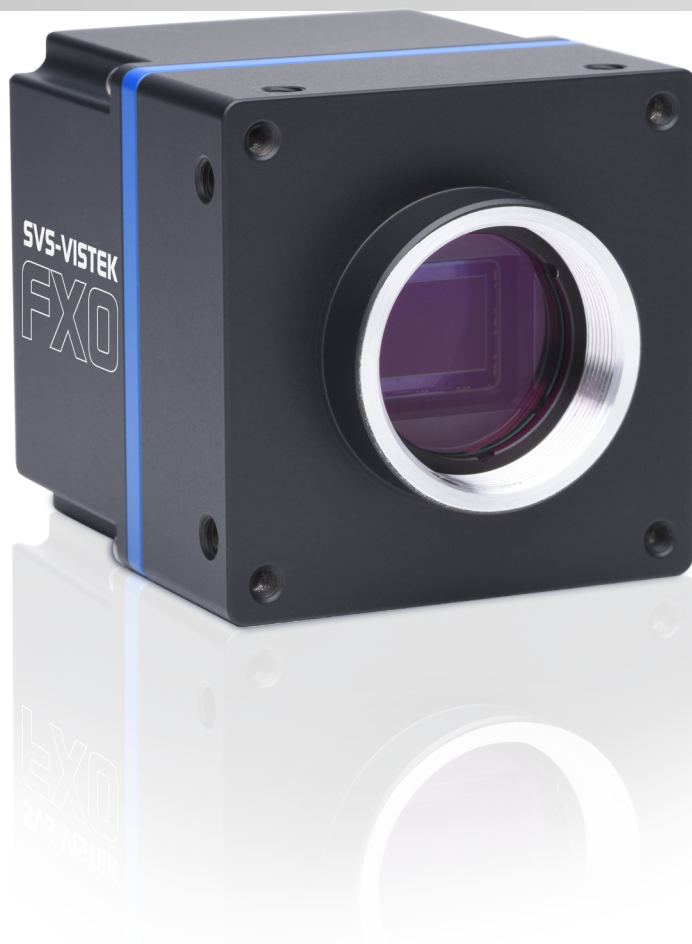

SVS-VISTEK



Manual FXO series CoaXPress

fxo540, fxo541, fxo542, fxo545, fxo546, fxo547, fxo990



Content

1	Company information	5
1.1	Standards	5
1.2	Disclaimer	5
1.3	Copyright notice	6
2	Legal information	7
2.1	USA and Canada	7
2.2	Europe	7
3	The FXO	8
3.1	CoaXPress-12 features (CoaXPress 2.0)	8
3.2	4I/O adds light and functionality	8
3.3	Lens control	10
3.3.1	Use liquid lens on C-mount	10
3.3.2	Use of Canon lenses	11
4	Getting started	12
4.1	Get help	12
4.2	Find camera specs	12
4.3	Power supply	12
4.3.1	Power safety	12
4.3.2	Connect the camera	12
4.4	Camera status LED codes	13
4.5	Software and firmware	14
4.5.1	Software for CoaXPress	14
4.5.2	SVCapture 2.x	14
4.5.3	Software development kit	19
5	Connectors	20
5.1	CoaXPress-12	20
5.2	Hirose I/O connector	21

6	Feature description	22
6.1	Basic features	22
6.1.1	Gain	23
6.1.2	Resolution	23
6.1.3	Offset	24
6.1.4	Color	25
6.1.5	Flip image	25
6.1.6	Binning	27
6.1.7	Decimation	28
6.1.8	GenICam	30
6.1.9	Trigger modes	31
6.1.10	Shutter modes	34
6.1.11	Exposure	39
6.1.12	Exposure speed	39
6.1.13	Auto exposure	40
6.1.14	Acquisition and processing time	41
6.1.15	Bit depth	41
6.1.16	ROI / AOI	44
6.2	Camera features	44
6.2.1	Glass filter	44
6.2.2	Shading correction	44
6.2.3	Defect pixel correction	48
6.2.4	Look-up table	53
6.2.5	ROI / AOI	55
6.2.6	Basic capture modes	56
6.2.7	Read-out control	57
6.2.8	Temperature sensor	58
6.2.9	Fan control	58
6.2.10	System clock frequency	59
6.2.11	Predefined configurations (user sets)	59
6.2.12	Particle Image Velocimetry	60
6.3	I/O Features	62
6.3.1	GenICam	62
6.3.2	Assigning I/O Lines - IOMUX	63
6.3.3	PWM	69
6.3.4	LED strobe control	73
6.3.5	Sequencer	75
6.3.6	Optical input	80
6.3.7	PLC / Logical operation on inputs	80
6.3.8	Serial data interfaces	82
6.3.9	Trigger-edge sensitivity	83
6.3.10	Debouncing trigger signals	84
6.3.11	Prescale	86

7	Dimensions	87
7.1	C-mount	87
7.2	fxo540, fxo541, fxo542, fxo545, fxo546, fxo547	88
7.3	fxo990	91
8	Appendix	94
8.1	I/O driver circuit schematics	94
8.2	IP protection classes	95

1 Company information

SVS-VISTEK GmbH

Mühlbachstr. 20

82229 Seefeld

Germany

Tel.: +49 (0) 81 52 9985-0

Fax: +49 (0) 81 52 9985-79

Mail: info@svs-vistek.com

Web: <https://www.svs-vistek.com>

1.1 Standards

This manual is based on the following standards:

- DIN EN 62079
- DIN EN ISO 12100
- ISO Guide 37
- DIN ISO 3864-2
- DIN ISO 3864-4
- DIN ISO 16016:2002-5

1.2 Disclaimer

This manual contains important instructions for safe and efficient handling of SVCam cameras (hereinafter referred to as „camera“). This manual is part of the camera and must be kept accessible in the immediate vicinity of the camera for any person working on or with this camera.

Read carefully and make sure you understand this manual prior to starting any work with this camera. The basic prerequisite for safe work is compliant with all specified safety and handling instructions.

Accident prevention guidelines and general safety regulations should be applied.

Illustrations in this manual are provided for basic understanding and can vary from the actual model of this camera. No claims can be derived from the illustrations in this manual.

The camera in your possession has been produced with great care and has been thoroughly tested. Nonetheless, in case of any complaint, please contact your local SVS-VISTEK distributor. You will find a list of distributors in your area on www.svs-vistek.com

1.3 Copyright notice

Forwarding and duplicating of this document, as well as using or revealing its contents are prohibited without written approval. All rights reserved with regard to patent claims or submission of design or utility patent.

2 Legal information

Errors and omissions excepted.

These products are designed for industrial applications only. Cameras from SVS-Vistek are not designed for life support systems where malfunction of the products might result in any risk of personal harm or injury. Customers, integrators and end users of SVS-Vistek products might sell these products and agree to do so at their own risk, as SVS-Vistek will not take any liability for any damage from improper use or sale.

2.1 USA and Canada



This device complies with part 15 of the FCC Rules. Operation is subject to the following conditions: (1) This device may not cause harmful interference, and (2) this device must accept any interference received, including interference that may cause undesired operation.

NOTICE

This equipment is compliant with Class A of CISPR 32. In a residential environment this equipment may cause radio interference.

This equipment has been tested and found to comply with the limits for a Class A digital device, pursuant to part 15 of the FCC rules.

It is necessary to use a shielded power supply cable. You can then use the “shield contact” on the connector which has GND contact to the camera housing. This is essential for any use. If not done and camera is destroyed due to Radio Magnetic Interference (RMI) WARRANTY is void!

- Power: US/UK and European line adapter can be delivered. Otherwise use filtered and stabilized DC power supply.
- Shock & vibration resistance is tested. For detailed specifications refer to the section on specifications ("[Specifications](#)").

2.2 Europe



This camera is CE tested, rules of EN 55022:2010+AC2011 and EN61000-6-2:2005 apply.

The product is in compliance with the requirements of the following European directives:

- 2014/30/EU Electromagnetic compatibility (EMC)
- 2011/65/EU Restriction of the use of certain hazardous substances in electrical and electronic equipment (RoHS)

All SVS-VISTEK cameras comply with the recommendation of the European Union concerning RoHS Rules.

3 The FXO

The FXO is a camera series designed for high-end machine vision with a C-mount connection. Only Sony image sensors with excellent optical performance and high bandwidth are used in the FXO. Advanced electronic circuitry, an excellent temperature management and low power dissipation make the basis for optimal performance of even the most demanding image sensors. Equipped with the fastest interfaces from the world of image processing, the FXO allows the high bandwidths of modern image sensors to be transferred into the application.

The CoaXPress-12 interface is suitable for applications with extremely stable data rates and high requirements on trigger latency.

3.1 CoaXPress-12 features (CoaXPress 2.0)

CoaXPress-12 (CXP) is the latest development regarding high speed high volume data transfer for imaging. The interface needs a frame grabber. The CoaXPress standard is very precise and is incorporating a lot of features like power-over-CoaXPress (PoCXP) already in the standard definition.

Main advantages of CXP-12 are

- 12.5 Gbit/s transfer rate per line
- Lines can be teamed
- Provides data and power on a single line (PoCXP)
- Very thin and flexible 75 Ohm coaxial cables
- 25m data cable supported
- Extremely low latency times
- High uplink speed 41.6 Mbit/s
- Precise trigger over CXP (theoretical max. 300kHz)
- New, very robust DIN micro-BNC connector

3.2 4I/O adds light and functionality

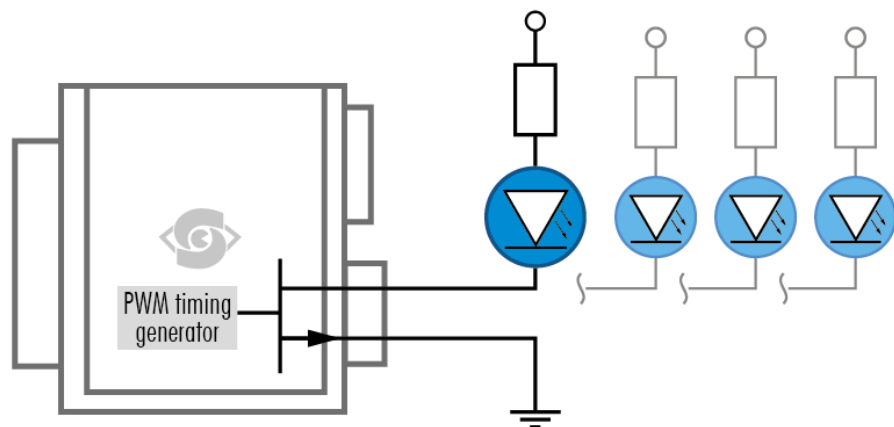

Fig.: 3-1: Illustration of 4I/O concept of switching LEDs

Your SVS-Vistek camera is equipped with the innovative 4I/O-interface allowing full light control, replacing external strobe controllers. Each of the outputs can be individually configured and managed using pulse width modulation. With its high current output, the camera is able to drive LED lights directly without external light controller.

The integrated sequencer allows multiple exposures with settings to be programmed, creating new and cost effective options. Logical functions like AND / OR are supported.

- Up to 4 x open drain high power OUT
- Up to 4 x high voltage IN - TTL up to 25 Volts
- Power MOSFET transistors
- PWM strobe control
- Sequencer for various configurations
- PLC functionality with AND, OR and timers
- Safe Trigger (debouncer, prescaler, high low trigger)

INFO

Find an example how to operate light control in the section on sequencer ("[Sequencer](#)" on page 75).

3.3 Lens control

Various SVCam models are supporting adjustable lenses. Focus and iris of the lens can be controlled from within the camera GenICam tree. A special Y-cable might be required, contact sales@svs-vistek.com.

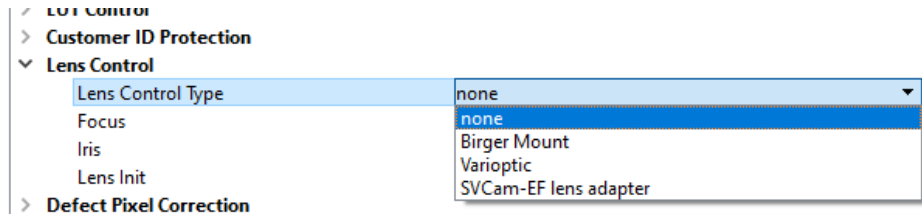

The following variable lens types are currently supported:

- MFT lenses (in Tracer series) have full support of lens focus, iris and zoom. Only available in Tracer models no options selectable in GenICam tree.
- Birger mount
Ask sales@svs-vistek.com for information of usability and restrictions of the Birger adapter.
- Varioptic liquid lens
Control of extremely fast focus cycles. Make sure sensor diameter is covered by lens.
- Canon EF lens
Focus and iris control is supported. Use high quality Canon lenses with machine vision applications. The SVCam-EF adapter can be acquired from SVS-Vistek.

INFO

Lens control (except MFT) will make use of the serial ports of the Hirose connector.

3.3.1 Use liquid lens on C-mount

We are supporting Varioptic liquid lenses. The liquid lens support does variable focus only, zoom and aperture control are not existing with the Varioptic liquid lens. You need a special serial cable with Hirose for connecting the lens to the camera, please ask your dealer. Being extremely fast and robust, the liquid lens is best choice as long as variable focus is sufficient in the application and you do not need a full lens control with aperture control and zoom functionality. In case of full lens control requirement, please refer to the TRACER series.

The lens is powered and controlled by the camera. The lens can be controlled via SDK functions or more easily via GenICam property.

Liquid lenses do have some advantages and disadvantages compared to glass optics:

- Advantages of liquid lenses
 - Extremely robust to mechanical shock (best choice for fast moving robotics) and acceleration
 - Fast focus (often significantly faster than 10 ms under common conditions)

- Disadvantages of liquid lenses
 - Limited resolution
 - High chromatic aberration
 - Any acceleration (gravitational as well as acceleration from movement) might increase spherical aberration as long as the force is working (will disappear if force has ceased within several 10ms)

3.3.2 Use of Canon lenses

We are supporting Canon EF lenses. The SVCam-EF adapter gives you the possibility to mount Canon EF lenses with full control of focus and iris. Canon lenses are well known for their optical excellence and combine perfectly to high resolution machine vision cameras.

This camera series does have the firmware support already included in the GenlCam tree and provides you with Canon lens control in all GenlCam based software packages.

4 Getting started

4.1 Get help

In case of issues with the camera we are happy to help. For being able to help you in a fast and efficient way, we ask you for a description of the issues using camera in your support request.

You can put your support request to us via our support form:

<https://www.svs-vistek.com/en/support/svs-support-request.php>

Please fill the form with special attention to camera model, frame grabber model and operating system. Our support team will come back to you.

4.2 Find camera specs

Our website does have all technical data of all our cameras online. Go to <https://www.svs-vistek.com/en/industrial-cameras/svs-cameras.php> for getting technical data sheets.

Cameras can be found by searching with series and model name or by using the SVCam camera finder. Having found the requested camera, the details/-download section provides you with manuals, drawings, soft- and firmware for your camera.

4.3 Power supply

4.3.1 Power safety

The camera does not have a power switch. The camera is powered on as soon power is available to the camera. This might happen via the Hirose connector or (in case of USB or CoaXPress) through the interface cables.

For making sure the camera is not connected to power

- Disconnect Hirose (or M12) plug from camera
- If the camera interface is USB or CoaXPress, disconnect interface connector from the camera
- Disconnect power plug from power AC wall outlet to disable the DC power supply as well.

The power supply must be easily accessible at all times! For Power specs, refer to the data sheet of your model.

Before connecting your camera to power, make sure your data cable is connected properly. Always connect data cable before power.

NOTICE The camera does not support hotplugging

4.3.2 Connect the camera

The camera is powered on by connecting power to the camera.

- Connect the power supply with the Hirose connector.

INFO

When using your own power supply (voltage range 10 -25 V DC), see also Hirose 12-pin layout of the power connector. For power input specifications refer to specifications.

Generally external power supply for USB3 Vision, CoaXPress (if PoCXP enabled) or PoE cameras is not needed. Nonetheless, you might want to use a separate power on the Hirose connector to reduce load on the data port. The external power on the Hirose connector is the preferred power source.

The power up is defined as follows:

- Power over USB3, CoaXPress port or GigE port (with PoE) or on the Hirose connector will power on the camera.
- If power is found on the Hirose connector, camera power supply will switch to the Hirose connector.
- If Hirose power supply is cut, camera power supply will switch back to power over USB3, PoE or power over CXP supply.

INFO

Camera power supply is not powering 4I/O LED lights.

4.4 Camera status LED codes

Latest SVCam CoaXPress cameras provides status information per CXP line. A LED is located close to each CXP connector and will indicate the current status for the appropriate CXP line. The LEDs will change color and rhythm.

The meaning of the CXP line blinking codes is depending whether PoCXP is used and translates as follows:















LED status code	PoCXP	Indication
	yes	system booting
	yes / no	nothing connected
	yes	connection detection
	no	connection detection
	yes	device / host incompatible
	no	device / host incompatible
	yes	PoCXP overcurrent
	yes / no	connected, no data
	yes / no	connected, waiting for event
	yes / no	connected, data transfer
	yes / no	data transfer error (e.g. CRC)
	yes / no	connection test packages
	yes / no	compliance test mode enabled
	yes / no	system error

Fig.: 4-1: Camera status LED codes

4.5 Software and firmware

Further information, documentations, release notes, latest software and application manuals can be downloaded in the download area on SVS-Vistek [download area](#). Depending on the type of camera you bought, several software packages apply.

If you are logged in, this is the location to find latest releases of firmware upgrades of your camera model as well.

4.5.1 Software for CoaXPress

CoaXPress is a well defined standard protocol. As there is the need for a hardware grabber, the grabber manufacturer is providing software for CoaXPress cameras. Please refer to the manufacturer of your CoaXPress grabber device.

The latest SVCapture (starting with version 2.5.4) is able to run CoaXPress cameras with Euresys CoaXPress interface cards and their GenTL drivers respectively. SVCapture providing a GenICam interface tree with its GenICam properties. You might need your framegrabber's manufacturer software for viewing images though.

Please read the SVCam Kit Quick Guide regarding install.

4.5.2 SVCapture 2.x

SVCapture is the recommended, GenICam-based software to operate SVCam industrial cameras. Your SVCam combined software installer including:

- SVCapture 2.x
(a viewer/controller program for SVCam cameras)
- PC USB3 driver & filter driver
- GenTL_Drivers
(GenICam drivers and transport layer DDLs for Camera Link, CoaXPress, USB3, GigE / 10 GigE)
- C/C# programming libs and interface

SVCapture 2.x is a GenICam/XML based software tool provided for free. It is created to show the capabilities of your SVS-Vistek camera and to show/modify values to your cam.

Get control of exposure timing, trigger delay, image correction etc. or control up to 4 LED lights connected to the SVCam directly via "[GenICam](#)" on page 62 control. Use the built-in "[Sequencer](#)" on page 75 to program several intervals executed by a single trigger impulse.

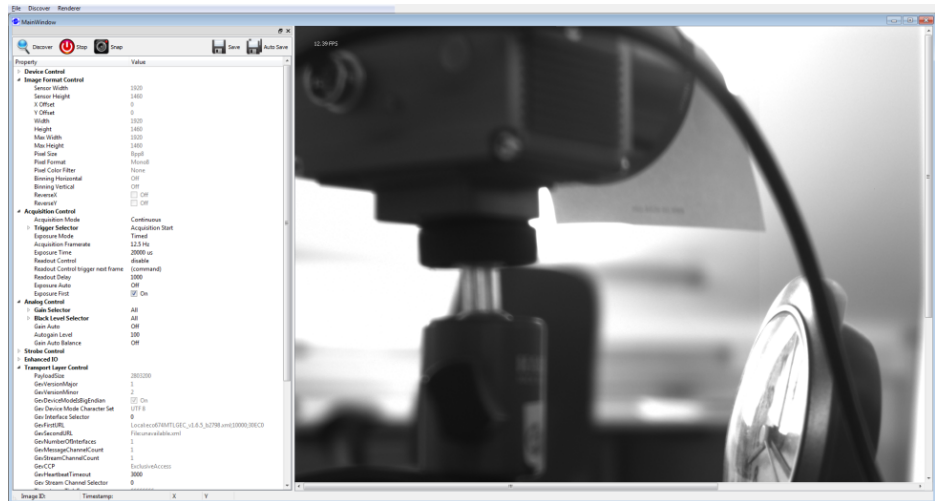

Fig.: 4-2: Screenshot of SVCapture 2.x: GenICam tree and current image

Setup of SVCapture2

Installation procedure may differ from PC to PC. It is recommended to install the whole software package. For this step it is necessary to have root access to your computer.

1. Copy or expand the installation executable file to your hard drive.
2. Start installation. Read and accept the terms of license agreement.



3. Choose destination folder and select necessary modules / drivers. The TLxx modules are the GenTL drivers, necessary as well if you want to use

SVS-Vistek driver with third party software.

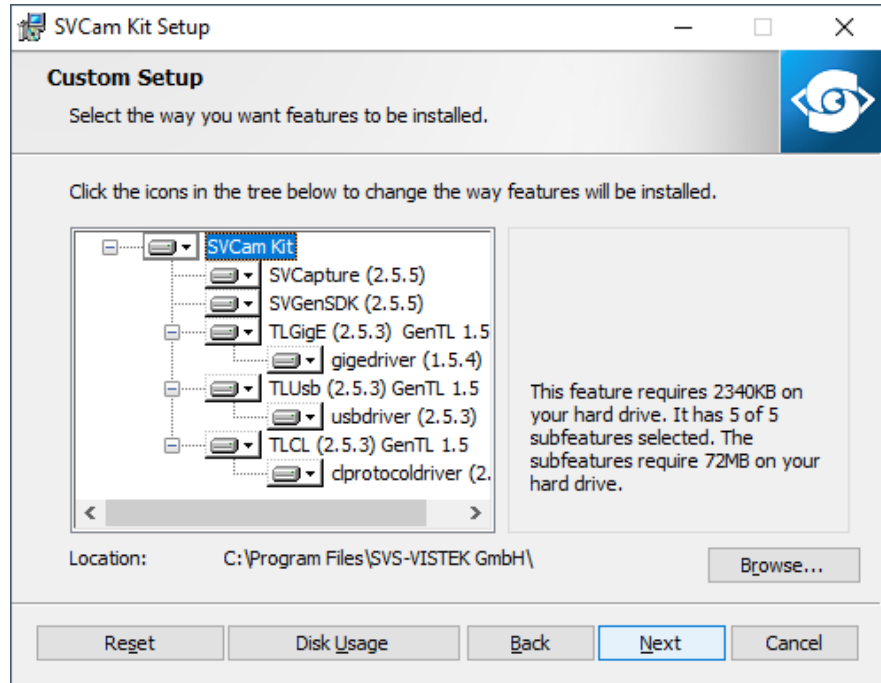

4. In case of system warnings regarding modification of USB3 drivers or GigE/10GigE filter drivers: The specified performance is possible only with these highly optimized drivers. Accept these modifications.



Initialization

First launch

1. Connect the camera to your computer. In case of a new USB3 camera driver hardware installation notice will pop up.

2. Start SVCapture. SVCapture will try to discover your camera.

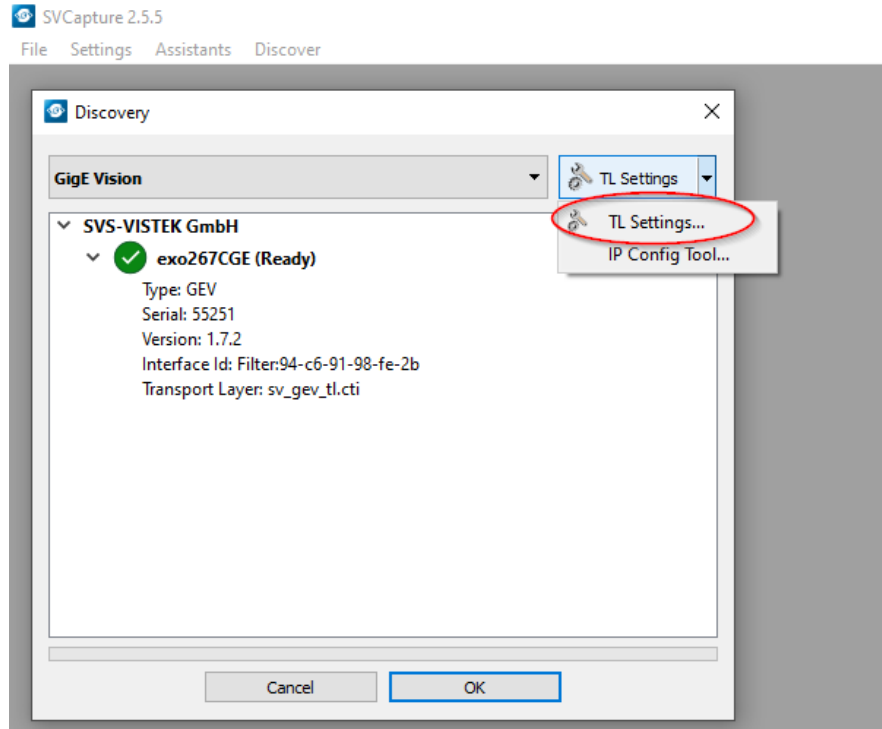

3. Click on the camera being found and you're connected.

Depending on your interface type, with TL Settings you are able to adjust which interface types should be included in the camera discover process.

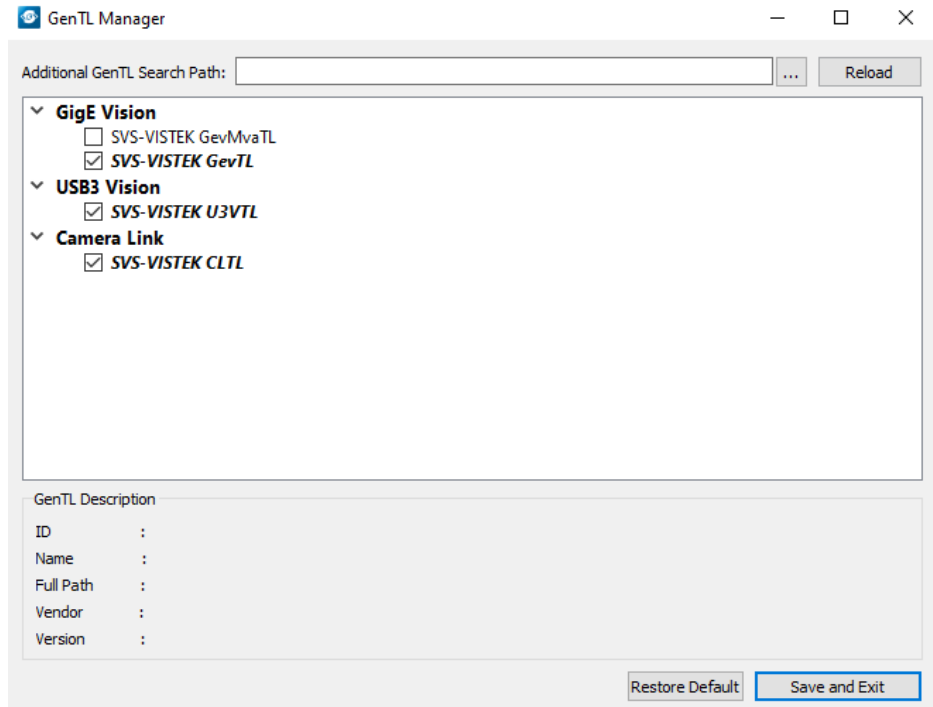

INFO

If you have installed third-party GenTL drivers (e.g. Euresys CoaXPress or Camera Link drivers), they should be selectable as well. This works only if third-party software has been installed before SVCapture.

- Find and adjust your camera features in the GenICam tree. Click and adjust items by number (1.) or slider (2.) and start grabbing images from the camera.

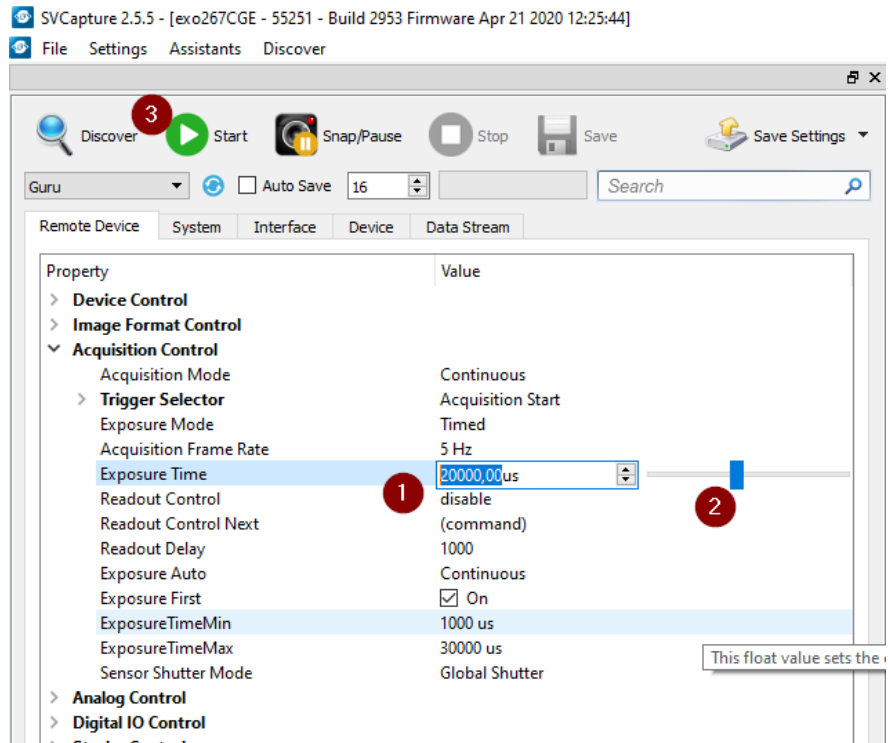

USB 3.0 driver

You can find the USB 3.0 driver which has been installed automatically within the hardware manager:

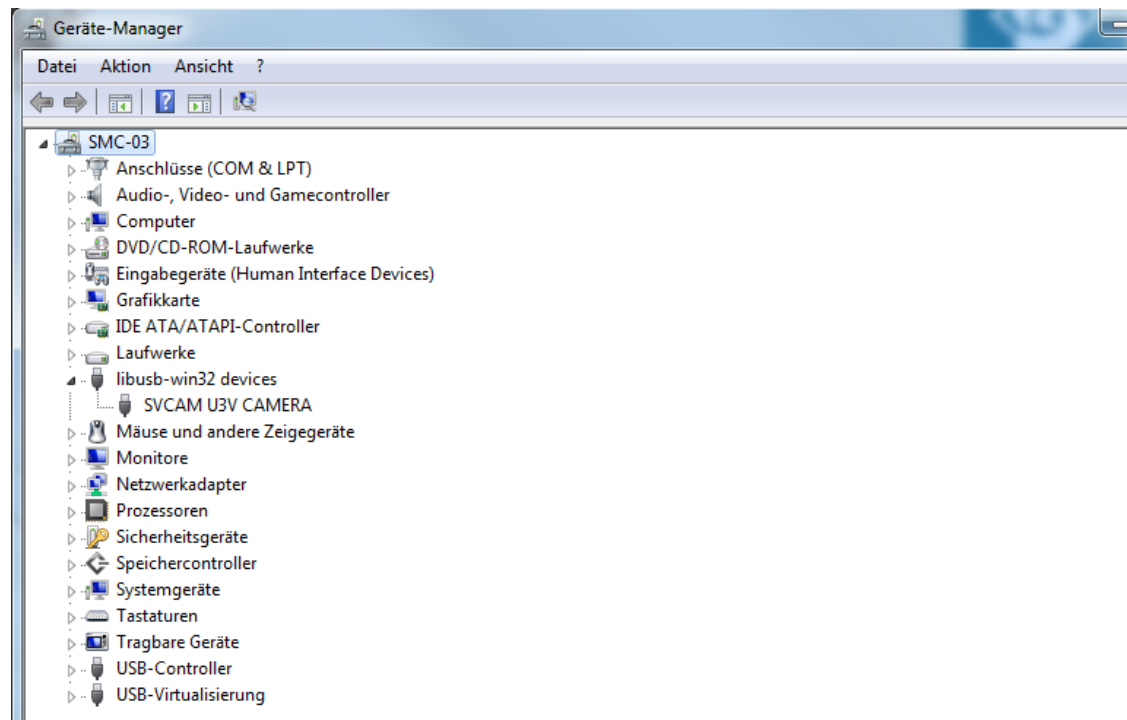

4.5.3 Software development kit

The SDK is based on C programming language and is installed together with SVCapture2. The SDK supports C and C++. For a typical installation, the libraries, header files, and examples are located in the directory:

C:\Program Files\SVS-VISTEK GmbH\SVCam Kit\SDK

INFO

Refer to the “Getting started with SDK” manual for first steps in programming your SVS-Vistek camera. This document should be included in the docs section of your installation.

The following platforms are supported:

- X86 (Windows, Linux, MacOS support on request)
- ARM (Nvidia Jetson TX1/TX2)

5 Connectors

Cameras from SVS-Vistek feature a combined I/O and power supply connector (Hirose) and a data connector.

5.1 CoaXPress-12

CoaXPress-12 (or CoaXPress 2.0) supports a bandwidth of up to 12.5 Gbit/s per line. The connector is a μ BNC connector, which is different to CoaXPress-6 connectors. Cable is 75 Ohm, RG187 recommended. SVS-VISTEK uses female connectors on their cameras according to J11A standard. You need cables with male connectors (plugs).



CoaXPress standard supports camera control and power over CoaXPress (PoCXP, 24V@13W). It is recommended to use the frame grabber power supply over CoaXPress.

5.2 Hirose I/O connector

The Hirose™ connector provides power, input and output signal access. Max power out is 2 Amperes peak.

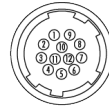

Hirose Pinout

Pin	Signal ECO, ECO2, EVO, HR (CL medium, GigE only)	Signal EXO, FXO, HR (CL De., CXP), SHR	Signal 4 I/O for option ECO
1	V IN- (GND)	V IN- (GND)	V IN- (GND)
2	V IN+ (10 – 25V)	V IN+ (10 – 25V)	V IN+ (10 – 25V)
3	RxD (RS232) not available for PoE versions	IN 4 RxD (RS232)	not connected
4	TxD (RS232) not available for PoE versions	OUT 4 TxD (RS232)	not connected
5	IN 1 (0 – 24 V)	IN 1 (0 – 24 V)	IN 1 (0 – 24 V)
6	IN 2 (0 – 24 V)	IN 2 (0 – 24 V)	IN 2 (0 – 24 V)
7	OUT 1 (open drain)	OUT 1 (open drain)	OUT 1 (open drain)
8	OUT 2 (open drain)	OUT 2 (open drain)	OUT 2 (open drain)
9	IN 3+ (RS422)	IN 3+ (opto IN +)	IN 3 (0 – 24 V)
10	IN 3 – (RS422)	IN 3 – (opto IN –)	IN 4 (0 – 24 V)
11	OUT 3+ (RS422)	OUT 3 (open drain)	OUT 3 (open drain)
12	OUT 3 – (RS422)	OUT 0 (open drain)	OUT 4 (open drain)
	Shielding	Shielding	Shielding

Fig.: 5-1: I/O Hirose connector layout

Inputs and outputs connect via [4I/O-matrix](#) in the GenICam software tree to the appropriate actions. For detailed information about switching lights with the power outputs via GenICam, refer to "[LED strobe control](#)" on page 73.

Type	HR10A-10R-12P
Matching Connector	HR10A-10P-12S

Table: 5-1: Hirose connector types

INFO

PoE (Power over Ethernet) models do not support RS232 on pins 3 & 4.

6 Feature description

This chapter covers features of SVCam cameras. Not every feature might be supported by your specific camera model. For information about the features of your specific model, please refer to the specifications area of our website with your exact model.

<https://www.svs-vistek.com/en/industrial-cameras/svs-svcam-searchresult.php>

6.1 Basic features

This section covers basic functionality of area sensor cameras.

6.1.1 Gain

Setting gain above 0 dB (default) is a way to boost the signal coming from the sensor. Especially useful for low light conditions. Setting gain amplifies the signal of individual or binned pixels before the ADC. Referring to photography adding gain corresponds to increasing ISO. Increasing gain will increase noise as well.

add 6 dB	double ISO value
6 dB	400 ISO
12 dB	800 ISO
18 dB	1600 ISO
24 dB	3200 ISO

Table: 6-1: Table of dB and corresponding ISO value

NOTICE Gain also amplifies the sensor's noise. Therefore, gain should be last choice for increasing image brightness. Modifying gain will not change the camera's dynamic range.

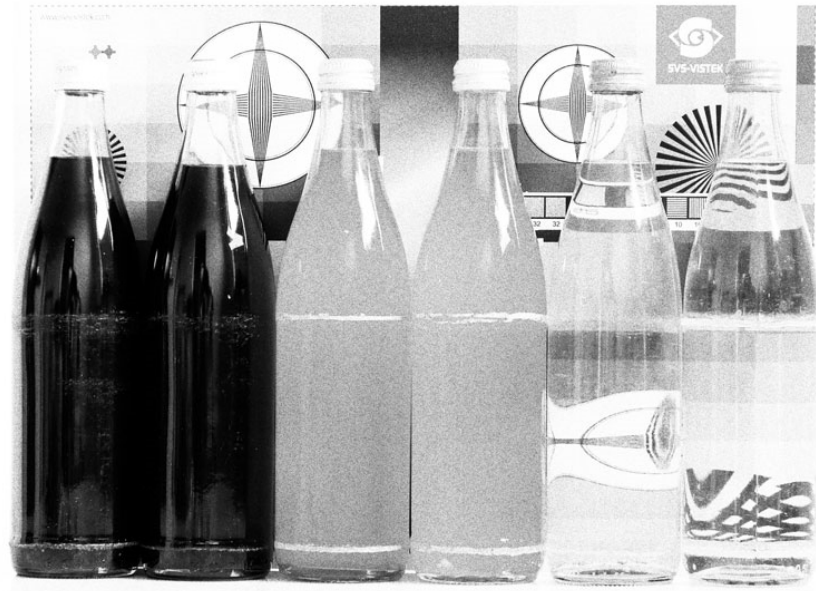

Fig.: 6-1: Noise caused by too much gain

Auto gain

For automatic adjustment of gain refer to auto exposure (see ["Auto exposure" on page 40](#)).

When using auto-gain with steps of gain the noncontinuous gain adjustment might be visible in final image. Depending on your application it might be preferable to use fixed gain values instead and modify exposure with exposure time.

6.1.2 Resolution

As mentioned in the specifications, there is a difference between the numerical sensor resolution and the camera resolution. Some pixels towards the borders

of the sensor will be used only internally to calibrate sensor values (“Dark pixels”). The amount of dark current in these areas is used to adjust the offset (see "Offset" below).

For calculating image sizes, the maximum camera resolution is determining maximum image resolution, refer to the specifications of the camera model).

6.1.3 Offset

For physical reasons the output of a sensor will never be zero, even the camera is placed in total darkness or simply closed. Always there will be noise or randomly appearing electrons that will be detected as a signal (dark noise: noise generated without light exposure).

To avoid this dark noise to be interpreted as a valuable signal, an offset will be set.

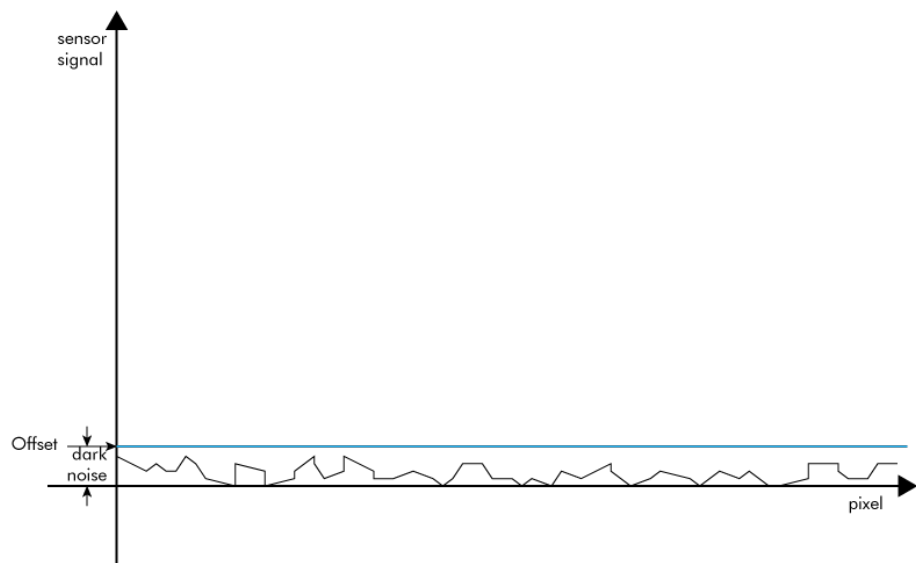

Fig.: 6-2: Dark noise cut off by the offset

Most noise is proportional to temperature. To spare you regulating the offset every time the temperature changes. A precedent offset is set by the camera itself. It references certain pixels that never were exposed to light as black. So the offset will be set dynamically and conditioned to external influences.

The offset can be limited by a maximum bit value. If higher values are needed, try to set a look up table.

INFO

For multi-tap CCD sensors, the offset can be altered for each tap separately.

6.1.4 Color

Color cameras are identical to the monochrome versions. The color pixels are transferred in sequence from the camera, in the same manner as the monochrome, but considered as “raw”-format.

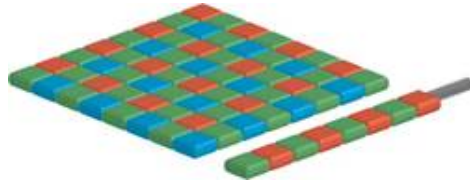

Fig.: 6-3: CCD with Bayer pattern

The camera sensor has a color mosaic filter called “Bayer” filter pattern named after the person who invented it. The pattern alternates as follows:

E.g.: First line: GRGRGR... and so on. (R=red, B=blue, G=green) Second line: BGBGBG... and so on. Please note that about half of the pixels are green, a quarter red and a quarter blue. This is due to the maximum sensitivity of the human eye at about 550 nm (green). De-Bayering is not done in the camera, it must be done in the client software(also refer to SDK functions). Not all sensors have the same sequence of color. The GenICam property **PixelColorFilter** indicates the sequence of the color pixels when reading color images.

Using color information from the neighboring pixels the RG and B values of each pixel is interpolated by software, e.g. the red pixel does not have information of green and blue components. The performance of the image depends on the software used.

Camera Link frame grabbers need information of the sequence order of the colors. The order depends on sensor type. USB3 and GigE cameras provide this in their XML file.

INFO

It is recommended to use an IR cut filter for color applications

White balance

The human eye adapts to the definition of white depending on the lighting conditions. The human brain will define a surface as white, e.g. a sheet of paper, even when it is illuminated with a bluish light.

White balance of a camera does the same. It defines white or removes influences of a color based on a non-white illumination.

- Continuous: Auto white balance will analyze the taken images and adjust exposure per color accordingly as long as the camera is taking images. Different colors of the same object in a sequence might be the result depending on the other objects in the image
- Once: Auto white balance will adjust white balance as soon it is started and will stop modifying parameters as soon white balance is finished.

6.1.5 Flip image

Images can be mirrored horizontally or vertically. Image flip is done inside the memory of the camera, therefore not increasing the CPU load of the PC.



Fig.: 6-4: Original image



Fig.: 6-5: Horizontal flip



Fig.: 6-6: Vertical flip

6.1.6 Binning

Binning provides a way to enhance dynamic range, but at the cost of lower resolution. Binning combines electron charges from neighboring pixels directly on the chip, before readout.

Binning is only used with monochrome CCD Sensors. For reducing resolution on color sensors refer to "[Decimation](#)" on the facing page.

On CMOS sensors, binning will not affect image quality. In any case, binning will reduce the amount of pixel data to be transferred.

Vertical binning

Accumulates vertical pixels.

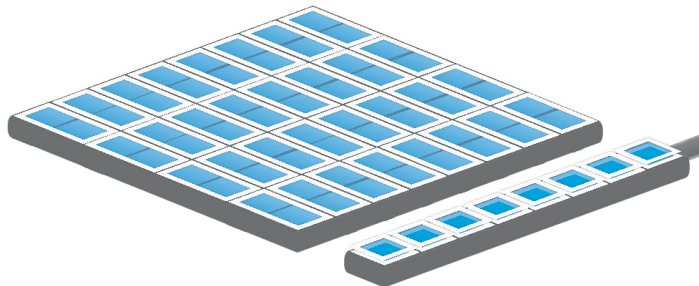

Fig.: 6-7: Vertical binning

Horizontal binning

Accumulates horizontal pixels.

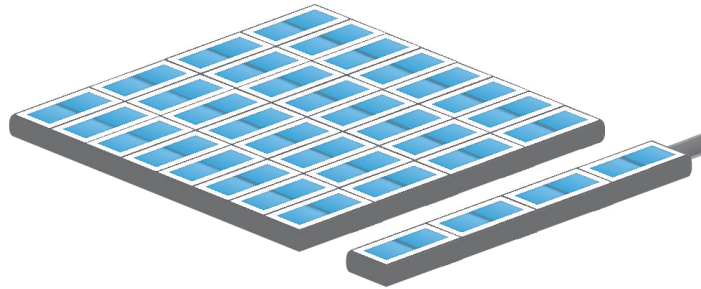

Fig.: 6-8: Horizontal binning

2×2 Binning

A combination of horizontal and vertical binning.

When DVAL signal is enabled only every third pixel in horizontal direction is grabbed.

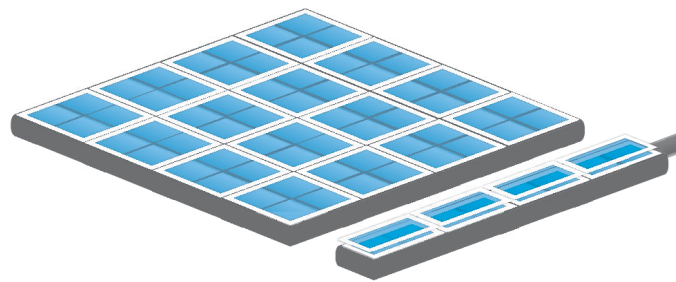

Fig.: 6-9: 2x2 binning

6.1.7 Decimation

For reducing width or height of an image, decimation can be used. Columns or rows can be ignored.

INFO

Refer to "[ROI / AOI](#)" on page 55 for reducing data rate by reducing the region you are interested in.



Fig.: 6-10: Horizontal decimation



Fig.: 6-11: Vertical decimation

Decimation on color sensors

The Bayer pattern color information is preserved with 1/3 horizontal and vertical resolution. The frame readout speed increases approx. by factor 2.5.

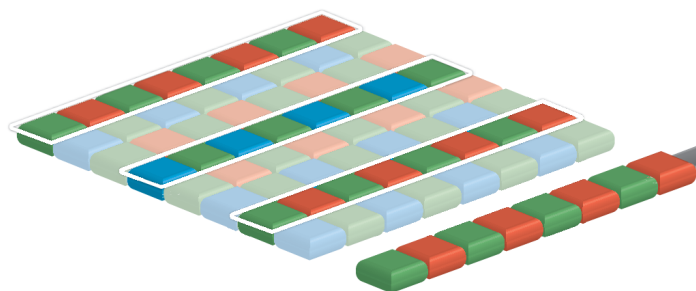

Fig.: 6-12: Decimation on color sensors

6.1.8 GenICam

GEN*i*CAM provides a generic programming interface to control all kinds of cameras and devices. Regardless of the interface technology (GigE Vision, USB3 Vision, CoaXPress, Camera Link, etc.) or implemented feature, the application programming interface (API) will always be the same. The SNFC makes sure the feature names are similar throughout the manufacturers, making it more easy to switch camera models.

The GenICam™ standard consists of multiple modules according to the main tasks to be solved:

- GenApi: configuring the camera
- SNFC: Standard Feature Naming Convention, a catalog of standardized names and types for common device features
- GenTL: transport layer interface, grabbing images
- GenCP: generic GenICam control protocol
- GenTL SFNC: recommended names and types for transport layer interface.

The GenICam properties are organized as a tree. Manufacturers can add more features.

With your SVCam, the GenICam tree does have some hardware related extensions, especially in the I/O sector. See the Quick guide install for a short introduction into the SVS-Vistek GenICam tree.

The GenICam properties are organized in views. The recommended way to view and adjust is by using SVCapture. If you want to have a full view of all adjustable GenICam items, activate the Guru mode. Beginner mode will show only most common attributes.

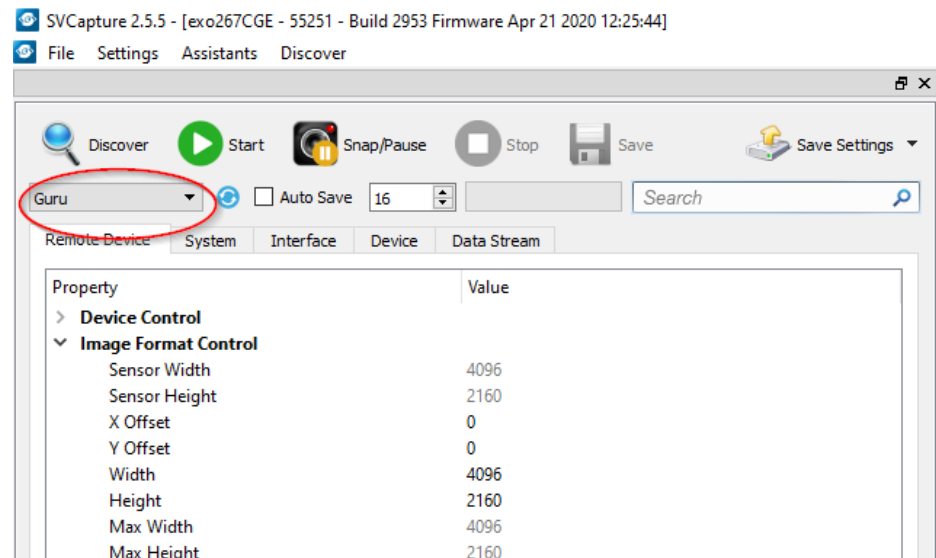

NOTICE All modifications in the GenICam tree will have immediate effect.

6.1.9 Trigger modes

To start capturing images, the camera has to receive a trigger signal. This trigger signal can be a software trigger, it might be an electric signal on the hardware I/O or it can be a timed trigger (sequence of images or "[Precision Time Protocol](#)").

Software trigger

The camera exposure can be started via software. With some interface types like GigE and USB3 it is impossible to have a 100% precise software trigger. CoaXPress and Camera Link permit relatively precise triggering of the camera. If you need to have a precise trigger, usage of "[External hardware trigger](#)" below is recommended.

External hardware trigger

External trigger with programmable exposure time. In this mode the camera is waiting for an external trigger pulse that starts integration, whereas exposure time is programmable via the serial interface and calculated by the internal microcontroller of the camera. Default input is Input1 for trigger.

At the rising edge of the trigger the camera will initiate the exposure.

The software provided by SVS-Vistek allows the user to set exposure time e.g. from 60 μ s to 60 sec (camera type dependent).

Exposure time of the next image can overlap with the frame readout of the current image (trigger pulse occurs when FVAL is high). When this happens, the start of exposure time is synchronized to the negative edge of the LVAL signal (see figure)

Mode 2: External Trigger with Programmable Exposure Time (overlap)

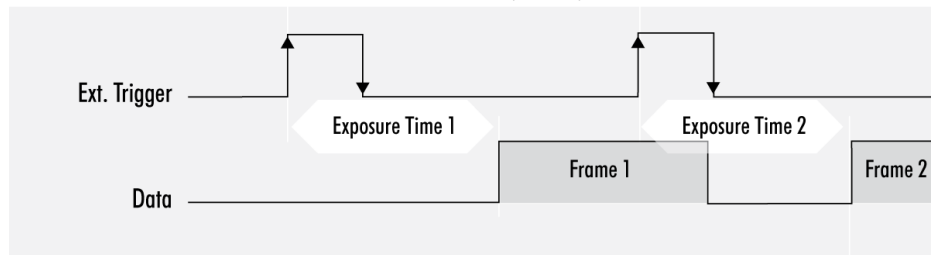

When the rising edge of trigger signal occurs after frame readout has ended (FVAL is low), the start of exposure time is not synchronized to LVAL and exposure time starts after a short and persistent delay.

Mode 2: External Trigger with Programmable Exposure Time (non overlap)

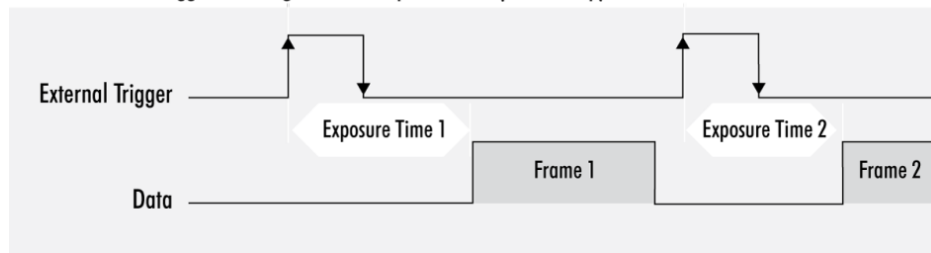

Exposure time can be changed during operation. No frame is distorted during switching time. If the configuration is saved to the EEPROM, the set exposure time will remain also when power is removed.

Details of external trigger mode

Diagrams below are equivalent for CCD and CMOS technique.

Mode 1: External Trigger with Pulse Width Exposure Control (non overlap)

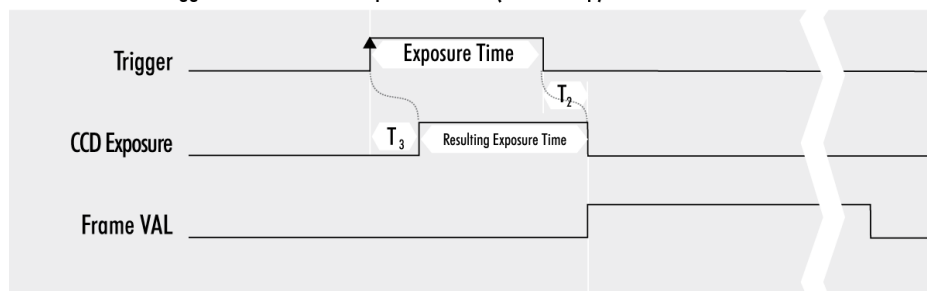

T_1 : Line Duration T_2 : Transfer Delay T_3 : Exposure Delay T_4 : min. Trigger Pulse Width

Mode 1: External Trigger with Pulse Width Exposure Control (overlap)

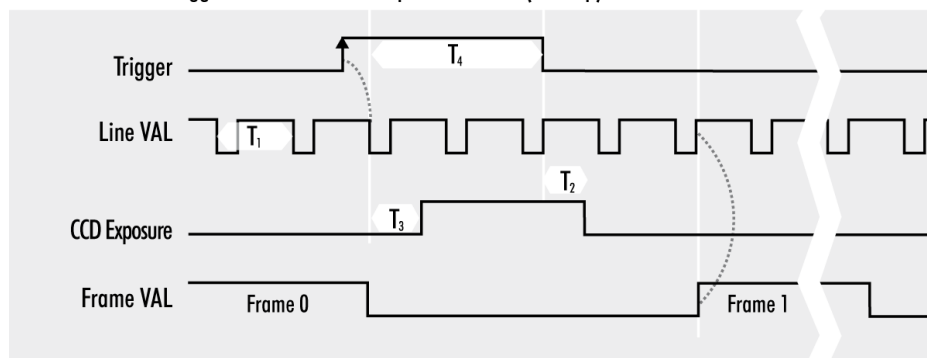

T_1 : Line Duration T_2 : Transfer Delay T_3 : Exposure Delay T_4 : min. Trigger Pulse Width

Mode 2: External Trigger with Programmable Exposure Time (non overlap)

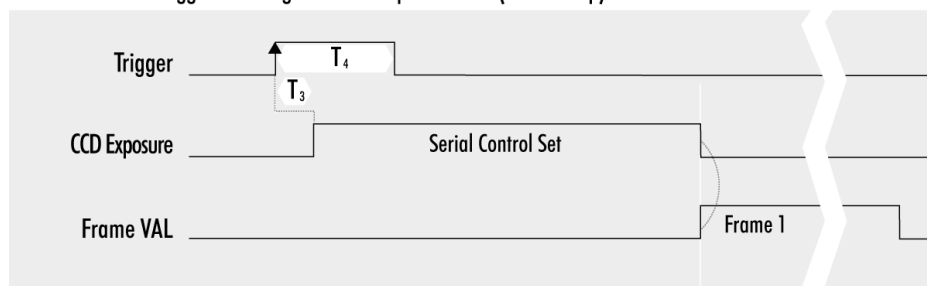

T_1 : Line Duration T_2 : Transfer Delay T_3 : Exposure Delay T_4 : min. Trigger Pulse Width

Mode 2: External Trigger with Programmable Exposure Time (overlap)

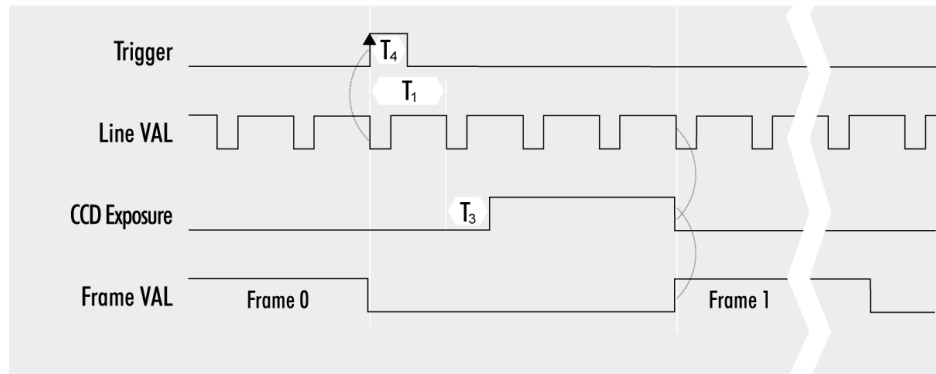

T₁: Line Duration T₂: Transfer Delay T₃: Exposure Delay T₄: min. Trigger

6.1.10 Shutter modes

CCD and CMOS area cameras consist of pixels, ordered in lines and columns. All pixels are exposed to light and then read out to camera electronics. There is a difference of reading out the sensor between global and rolling shutter. Especially flashing and moving objects might need more attention with rolling shutter.

There are 3 modes to operate a camera area sensor:

Global shutter mode

- Global reset of all pixels
- All pixels start light integration at the same time
- All pixels stop integration at same time
- Readout line by line after exposure of whole frame is completed

Artifacts

- All pixels show same movement artifacts
- In case of exposure time too long, all pixels blurred

Use short exposure times for preventing blur artifacts. Image of moving object on sensor must not move more than half pixel width.

Exposure with flash

Flash strobe at any time and length while exposing. With moving objects, light pulse has to be short enough to prevent blur artifacts.

Rolling shutter mode

- Pixel reset line by line
- Line by line light integration
- Integration starts with different point of time for each line
- All lines stop integration at different time
- Line readout immediately after line exposure
- Next integration has to wait for finished readout (per line)
- No external exposure control (expose while trigger signal active)

Limitations

Use short exposure times for preventing blur / deforming artifacts. Image of moving object on sensor must not move more than half pixel width. In case of moving objects, exposure movement on sensor has to be shorter than half a pixel for whole image.

Make sure your light is ON as long any pixel are going to be exposed. Total imaging time is exposure time plus scanning time.

Minimum scan time in most cases is about 1 frame length.

With rolling shutter the whole sensor has to be read out - always. That means applying ROI will reduce the amount of final data being transmitted out of the camera (and the frame rate might rise, due to the limited bandwidth of the

interface). Nonetheless, the maximum achievable frame rate with applied ROI will be the maximum frame rate of the sensor reading the full sensor area (internal full sensor speed), please refer to relating sensor specs.

Artifacts

- All pixel show same artifacts
- Deformed image of moving objects

Exposure with flash

flash control with rolling shutter

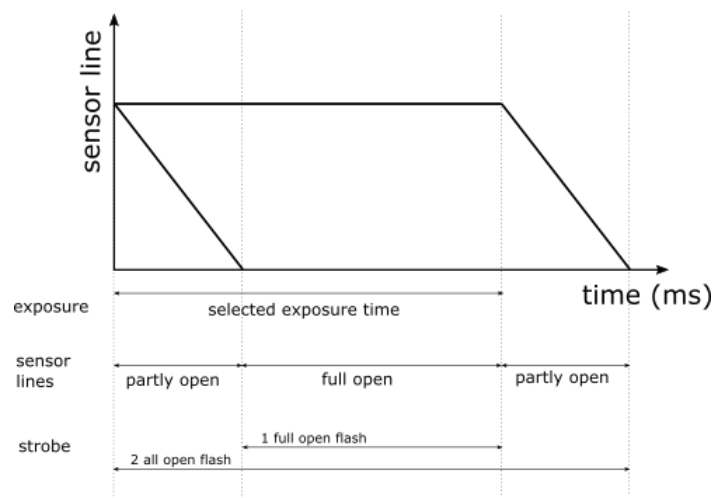

Fig.: 6-13: flash control with rolling shutter

- Flash strobe on whole exposure time
- or -
- Flash strobe only while all lines are sensitive to light at the same time (delay flash strobe until all lines are sensitive to light)

Make sure to protect from changing environment light (recommendation: flash strobe in darkness). Short Flash strobe times with moving objects.

Light control with rolling shutter

As being said, not all sensor lines are sensitive to light at the same time. Make sure your light is ON as long any pixel are going to be exposed. An exo183xGE i.e. needs about 62ms of minimal scanning time. An exo183xCL i.e. needs about 120ms of minimal scanning time. Minimum scan time in most cases is about 1 frame length.

There are 2 general guidelines for flashing with rolling shutter:

- Make sure your light is ON and stable the whole period of time while scanning / exposing. Minimum flash time is scanning time plus exposure time. In this case, while flashing you will get geometric distortions as mentioned above. Exposure will be determined by camera exposure time and light intensity.
- If flash time is less than scanning time then exposure time has to be at least scanning time + flash time, with a delay of scanning time. In other words, your exposure time will be scanning time plus flash time, while you use a flash delay of scanning time. Thus flash release will start after the delay of scanning time, as soon the sensor is fully open. You should keep the object in total darkness while the first scanning time.

In this case, as all lines are sensitive to light at the same time after the first scan time, flashing time can be as short as you like. You will not see the typical geometric rolling shutter distortions as shown above. Imaging will be similar to global shutter. Exposure will be determined by flash time / intensity.

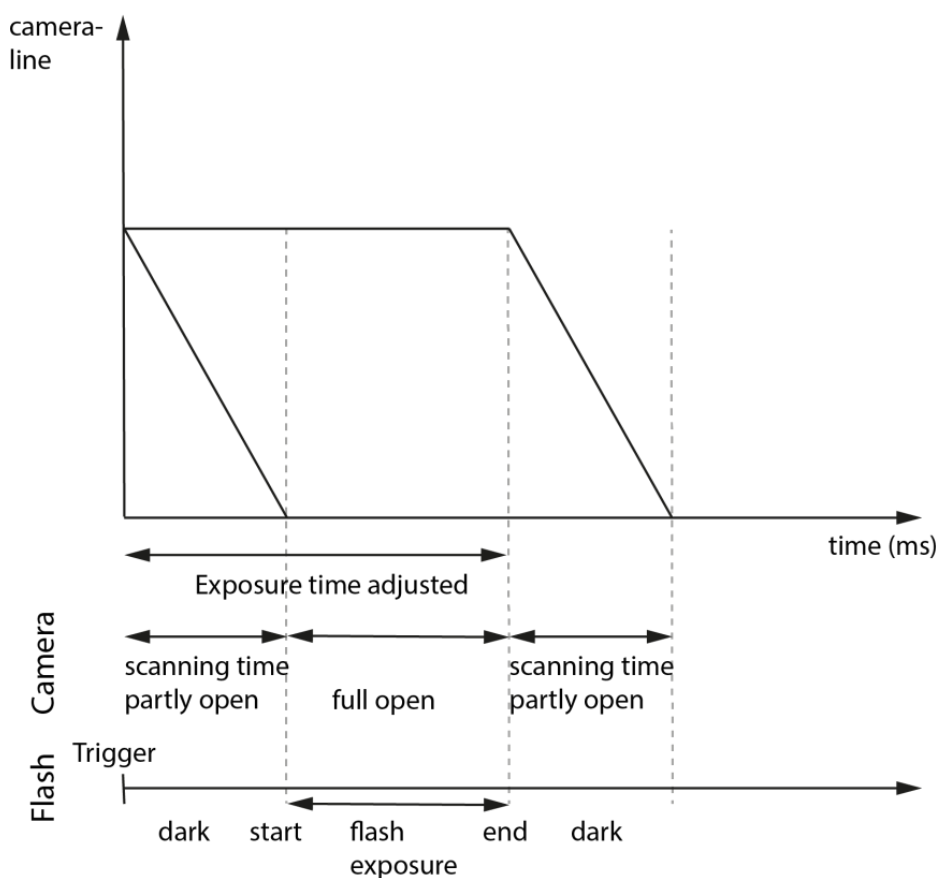

Fig.: 6-14: Rolling shutter lines light sensitivity versus time

As shown here, after triggering only part of the sensor is sensitive to light (scanning time). As soon as scanning time has finished, all pixels are sensitive to light, the sensor is fully open. While being fully open this is the time where flashing should happen. In the final scanning time, less and less pixels are sensitive to light until the sensor light sensitivity will finish.

Rolling shutter limitations

Due to the principles of rolling shutter, some standard features of SVS-Vistek cameras are not applicable.

- External exposure control (expose while trigger signal active) does not make sense with rolling shutter
- ROI with rolling shutter: With rolling shutter the whole sensor has to be read out - always. That means applying ROI will reduce the amount of final data being transmitted out of the camera (and the framerate might rise, due to the limited bandwidth of the interface). Nonetheless, the maximum achievable framerate with applied ROI will be the maximum framerate of the sensor reading the full sensor area (internal full sensor speed), please refer to relating sensor specs.

Calculate frame rates

According to the calculation below, the requested times for scanning through all lines of the sensor will affect maximum frame rate calculation as well.

In this example, the camera is an exo183 with 3672 lines and 54 dummy lines. Each line takes 22.2 ms readout time (depending on configuration). The camera does have about 300 μ s exposure time delay at worst case.

Frame rate calculation with exo183 with rolling shutter

lines			3672
dummy lines	+		54
total lines			3726
readout time 1x3_1Y	22,2 μ s	* 3726 =	82717,2 μ s
exp delay		+	300 μ s
frame readout time			83017,2 μ s

This is minimum time for camera readout with 0s exposure time.

Exposure time has to be added:			
frame readout time			83017,2 μ s
exposure time			2500 μ s
total frame time			85517,2 μ s
maximum sensor acquisition time	1/ frame time		11,6 fps

note: readout time 1x2_1Y = 32,63 μ s

Global Reset Release Mode

Global reset release mode is a special mode to operate rolling shutter sensors. All rolling shutter cameras from SVS-VISTEK GmbH can be operated in Global Reset Release mode. Global reset release shows advantages when operating light sources in non-constant light situations.

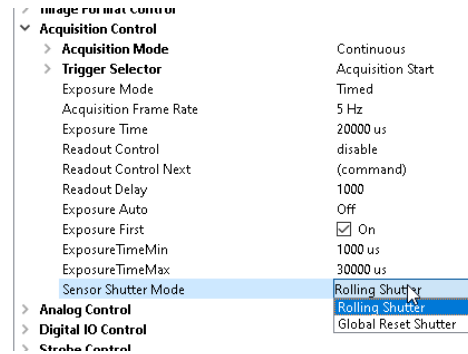

Fig.: 6-15: setup of global reset release mode in GenICam tree

Benefits

- All pixel reset all lines same time
- **Light integration starts with same point of time for each line**
- All lines stop integration at different time
- Readout line by line

Limitations

ROI limitations apply similar to rolling shutter.

- Next integration has to wait for finished readout of last active line
- No external exposure control (expose while trigger signal active)
- not useful with constant object illumination

Artifacts

- Different amount of blur on moving objects (more blur the later the readout)
- Deformed image of moving objects (see rolling shutter)
- brighter exposure the later the readout

Global reset mode with flash

The disadvantage of global reset release mode is lines at the end of readout are exposed to light longer than the lines at readout start, brightness is different. Using a strobe controller with flashed light will get rid of the issue.

Global reset release mode setup

- make sure of no external (constant) light source
- use flash only for object illumination
- set camera to global reset release mode
- start exposure time together with flash (flash strobe in darkness)

When flashing in global reset mode, the flash time will define the exposure time. Thus, an very time-stable flash control is essential.

Flash Control with Global Reset Release

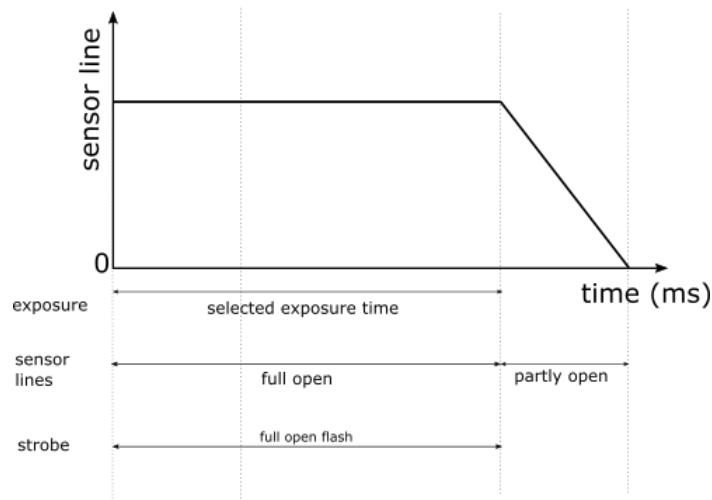

Fig.: 6-16: strobe control in global reset mode

In Global Reset Mode flash is starting together with exposure, all CMOS lines are sensitive to light. Flash time has to be shorter than exposure time. Exposure time is determined by flash time.

INFO

Strobe control jitter might be visible in the image as structures or as brightness instabilities.

We recommend using the very stable [integrated I/O flash control](#) for light control. Precision is about 1 tic or 15ns.

6.1.11 Exposure

- For various exposure and timing modes in chapter, see "[Basic capture modes](#)" on page 56.
- For combining various exposure timings with PWM LED illumination, refer to "[Sequencer](#)" on page 75.

Setting exposure time

Exposure time can be set by width of the external or internal triggers or programmed by a given value.

6.1.12 Exposure speed

Frames per second, or frame rate describes the number of frames output per second (1/ frame time). Especially GigE and USB cameras cannot guarantee predictable maximum frame rates with heavy interface bus load.

Maximum frame rate might depend on:

- Pixel clock
- Image size
- Tap structure
- Data transport limitation
- Processing time

6.1.13 Auto exposure

Auto Luminance or auto exposure automatically calculates and adjusts exposure time and gain, frame-by-frame.

The auto exposure or automatic luminance control of the camera signal is a combination of an automatic adjustment of the camera exposure time (electronic shutter) and the gain.

The first priority is to adjust the exposure time and if the exposure time range is not sufficient, gain adjustment is applied. It is possible to predefine the range (min. / max.-values) of exposure time and of gain.

The condition to use this function is to set a targeted averaged brightness of the camera image. The algorithm computes a gain and exposure for each image to reach this target brightness in the next image (control loop). Enabling this functionality uses always both - gain and exposure time.

Limitations

As this feature is based on a control loop, the result is only useful in an averaged, continuous stream of images. Strong variations in brightness from one image to next image will result in a swing of the control loop. Therefore it is not recommended to use the auto-luminance function in such cases.

6.1.14 Acquisition and processing time

The camera has to read the sensor, process the data to a valid image and transfer this to the host computer. Some of these tasks are done in parallel. This implies the data transfer does not end immediately after end of exposure, as the image has to be processed and transferred after exposure.

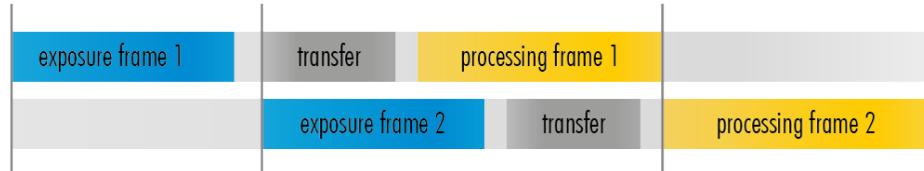

Fig.: 6-17: Acquisition and processing time

On the other hand, while processing and transferring the image the sensor might capture already the next frame.

6.1.15 Bit depth

Values of brightness are internally represented by numbers. The number of bits for brightness representation is limiting the number of color values that can be represented. Bit depth defines the maximum unique colors or gray levels in an image.

No of gray values = $2^{\text{bit depth}}$

All SVCam models support 8-bit format. In most cases, the sensor itself is limiting maximum bit depth. Refer to specifications whether your model is supporting higher bit depth.

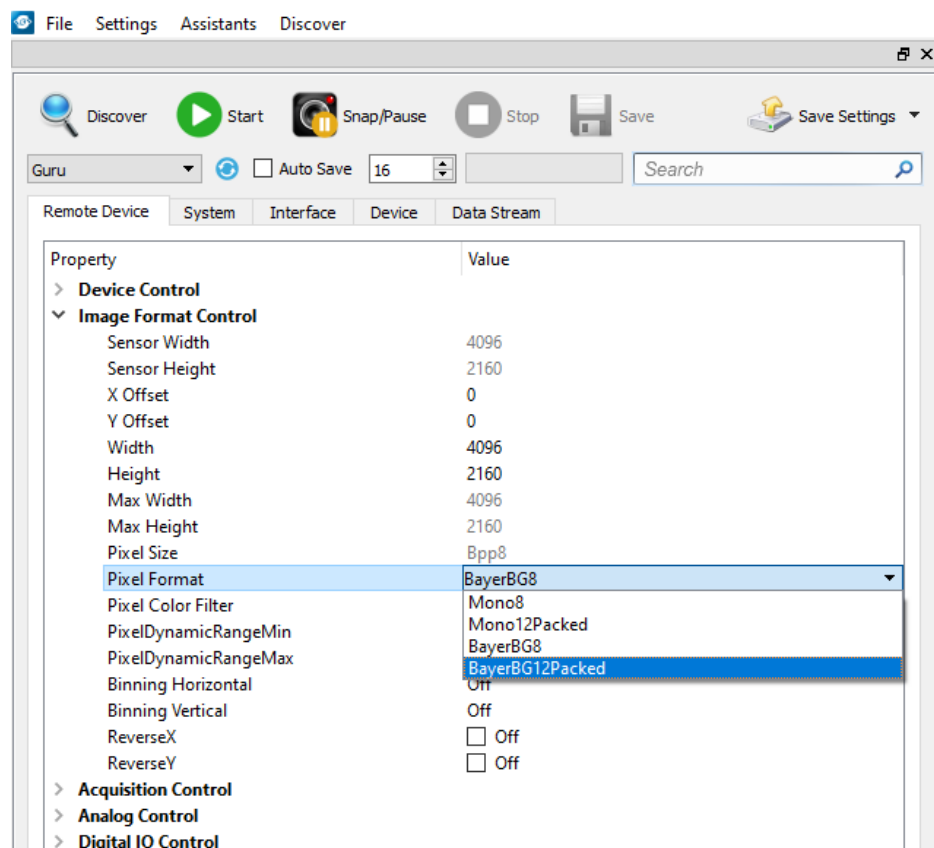

INFO

Depending on camera model, different bit depths are supported.

Packed format

Some camera models support “packed” bitformats. Instead of using 16 bit per pixel (and transferring a lot of zeroes), 2 bytes contain more information than only 1 pixel.

For example, in the image above, “Mono12Packed” is supported. Every pixel has a bit depth of 12 bit. Information transfer has to be in 8-bit steps (8, 16, 24 etc). By packing, 2 pixel can be transferred in 3 bytes (24 bit) instead of 2 x 16 bit (4 bytes). This increases bandwidth by 25%. This packing does not affect image quality, but the image needs to be unpacked (with an SVCam SDK function, very fast) after image acquisition before the image can be processed.

NOTICE

Unpacking has to be done manually, this is not a GenTL function. Thus, image acquisition in packed formats won't be supported by most 3rd party software products.

Separated bit depth of sensor and camera

Some camera models are supporting separated bit depth adjustment of sensor readout and camera readout. Thus you can read in an image e.g. in 12 bit from the sensor, apply a 12-to-8 bit look-up table and read from the camera as an 8 bit image.

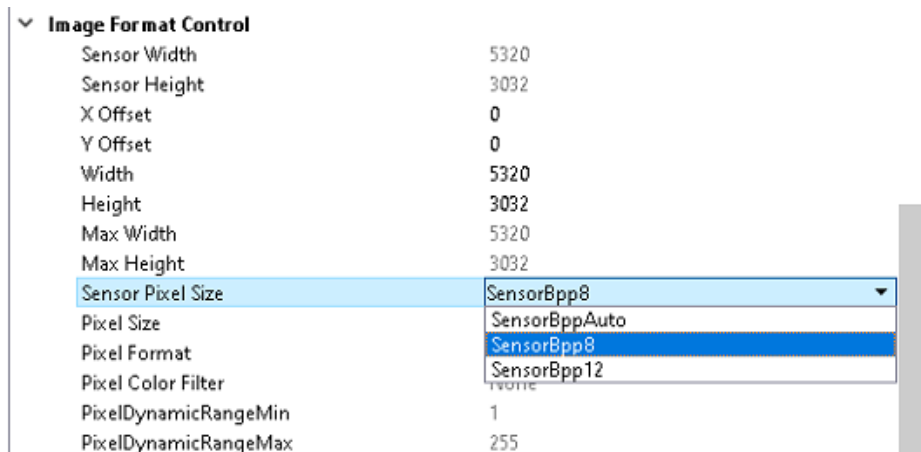

By default, Sensor Pixel Size is SensorBppAuto and should follow the adjustment of Pixel Size.

The final bit depth exported by the camera (camera readout) is adjusted with Pixel Size.

Bit depth and brightness with Sony Gen 4 sensors

The FXO series (XGE / CXP) shows different brightness when switching between 8-bit and 12-bit mode (SensorPixelSize). If you read sensor 8 bit, the upper 4 bits of the sensor range are cut off.

8-bit mode sensor pixel size is 50% faster, but the (bit-cut-off) reduced full well capacity also results in a higher noise percentage. To use the full dynamic range of the sensor, the sensor must be read out 12 bit, the transmission can then be done with (reduced) 8 or 12 bit, as required.

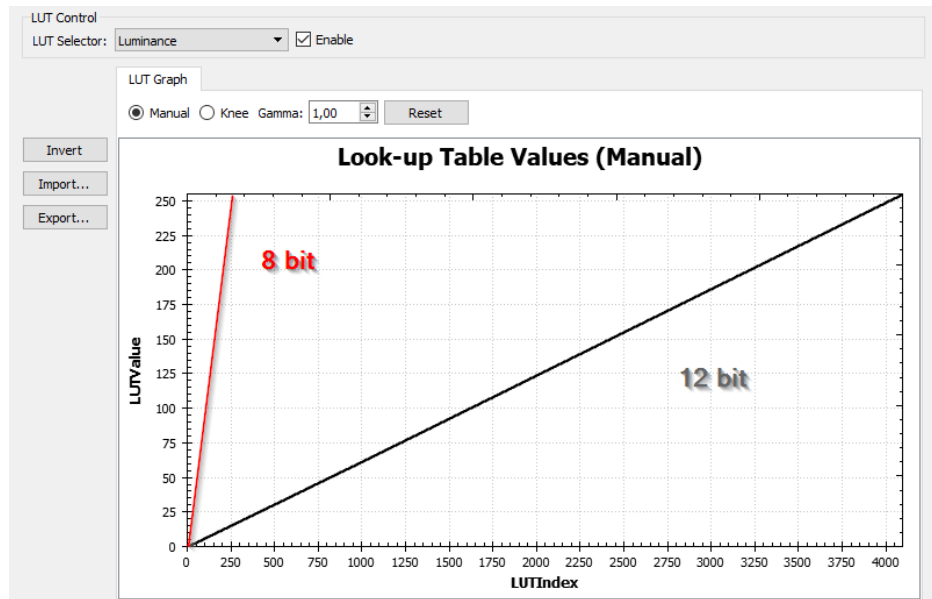

The red 8 bit curve above is the result of the sensor 12 bit capacity with the used 8 bit range. The black 12 bit curve is an applied linear 12-to-8 bit look-up table.

6.1.16 ROI / AOI

In partial scan mode or Area-Of-Interest (AOI) mode (or Region-Of-Interest (ROI) mode) only a certain region of the sensor will be read.

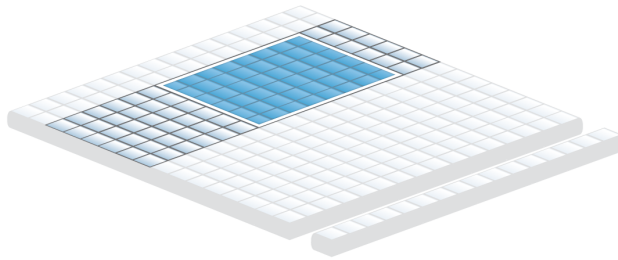

Fig.: 6-18: AOI on area sensor

Selecting an AOI will reduce the number of horizontal lines being read. This will reduce the amount of data to be transferred, thus increasing the maximum speed in terms of frames per second.

With CCD sensors, setting an AOI on the left or right side does not affect the frame rate, as lines must be read out completely.

With CMOS Sensors, AOI is sensor dependent. Some CMOS sensors require the camera to read full horizontal sensor lines internally. Reducing horizontal size with AOI might result in limited frame rate gain.

6.2 Camera features

The camera is embedded in its electronics and firmware feature.

6.2.1 Glass filter

The camera is equipped with a glass filter for sensor protection reasons (dust). Optical length of the glass filter is included in the mount specifications.

6.2.2 Shading correction

The interactions between objects, illumination, and the camera lens might lead to a non-uniform flatfield in brightness. Shading describes the non-uniformity of brightness from one edge to the other or center towards edge(s).

Original and shading corrected image

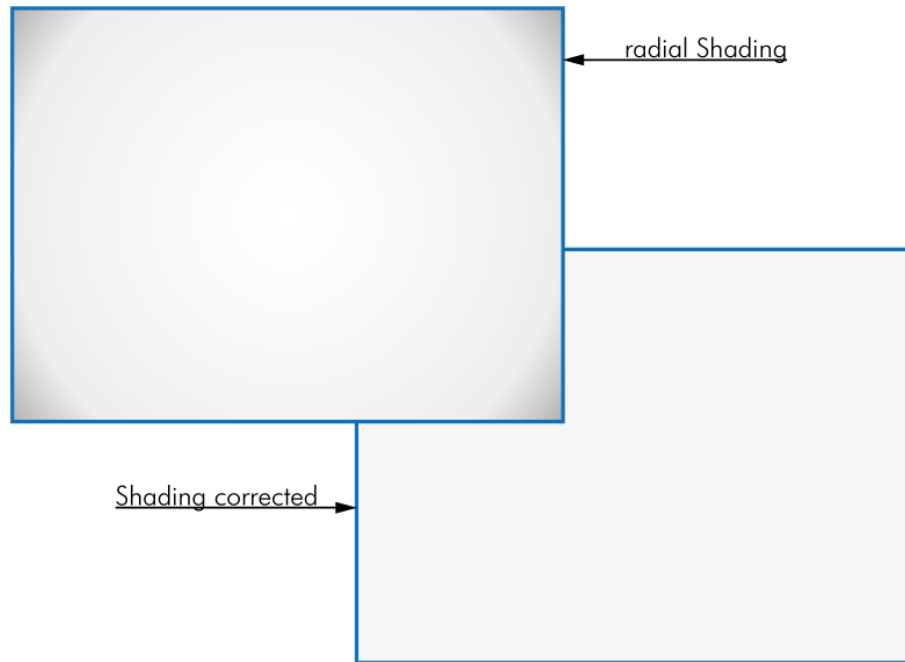

This shading can be caused by non-uniform illumination, non-uniform camera sensitivity, vignetting of the lens, or even dirt and dust on glass surfaces (lens).

Shading correction is a procedure to create a flatfield image out of a non-uniform image regardless of the reasons of the non-uniformity. Before doing shading correction, make sure your lens is clean and in perfect condition. If the lens is not clean or the lighting not uniform, the algorithm tries to compensate these as well - resulting in a wrong shading table and visible artifacts, loss of details or local noise in the final image.

In theory, there are several locations of shading

- In the host computer: significant loss of dynamic range
- In the camera, digital: better (smoother) shading than on computer, still loss of dynamic range
- In the camera, analog: set gain/offset locally direct on sensor to get optimum shading correction with only small changes in dynamic range

It is important to have in mind that shading correction might reduce dynamic range of the images taken. By using different gains and offsets on the sensor local noise might be less uniform. Structures in the reference image might lead to visible shading artifacts.

In contrary to any shading correction being done after image recording, the method described here will hardly affect the dynamic range of the image.

The task is done with shading maps. Shading maps are test files containing a description for the camera how to balance shading control. Shading maps can be created and uploaded to the camera with SVCapture. The shading map creation process takes any image with any (!) illumination and creates a shading map out of it. This shading map afterwards will be uploaded into the camera.

How it works

The tool will divide the image into squares of 16x16 pixel. Out of every 16x16 pixel cluster a set of shading values consisting of specific gain and offset per cluster is calculated. The resulting map can be uploaded into the camera and will compensate for any shading, lens-based or based on illumination.

Control shading via enabling/disable shading control. Up to 3 different shading maps can be uploaded and connected with a user preset. Like this by switching the user set you can use 3 different shadings (use this for example if the illumination in 3 colors is not the same) in sequential shots.

NOTICE Shading correction is possible with certain models only. See camera specs whether your model does support this. In case your camera is not supporting, the assistant will not be selectable.

First, shading reference images have to be taken with shading correction disabled (use 16 images minimum). Save it on disk. Use std .bmp files here, if possible with more than 8 bit.

1. Run shading assistant->Generate Map

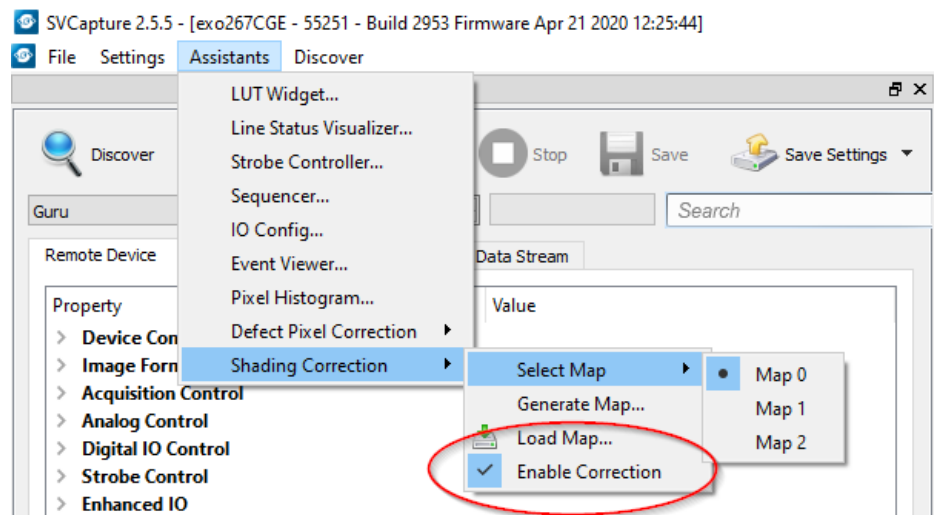
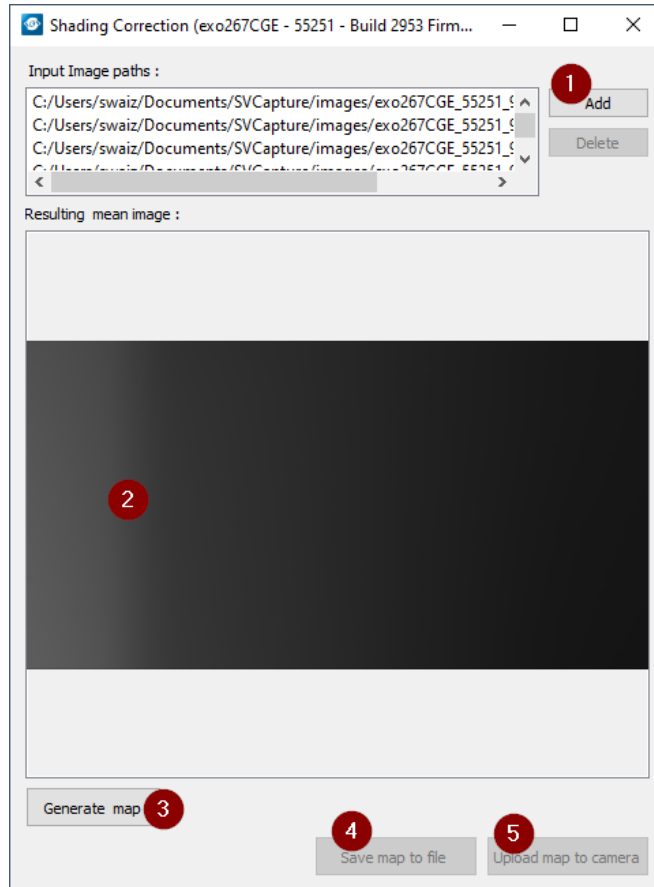
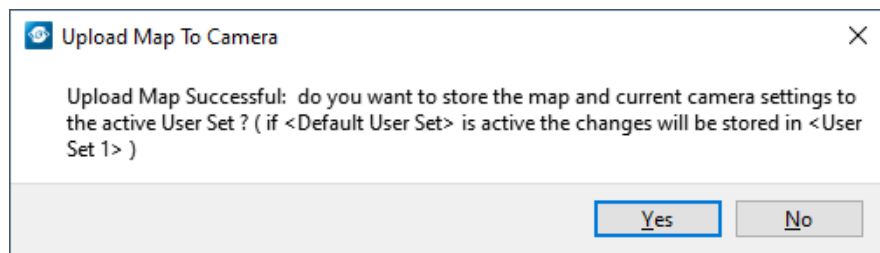

Fig.: 6-19: Shading control disabled

2. With SVCapture load these reference images.



3. See shading in the preview
4. Generate the shading map
5. Save map to disk. This file can be used in programmed environments via SDK as well.
6. Upload it to the camera and see the result. If lighting did not change from start of procedure, you should see a uniform image with enabled shading control.



7. Run camera with same lighting to see corrected image.

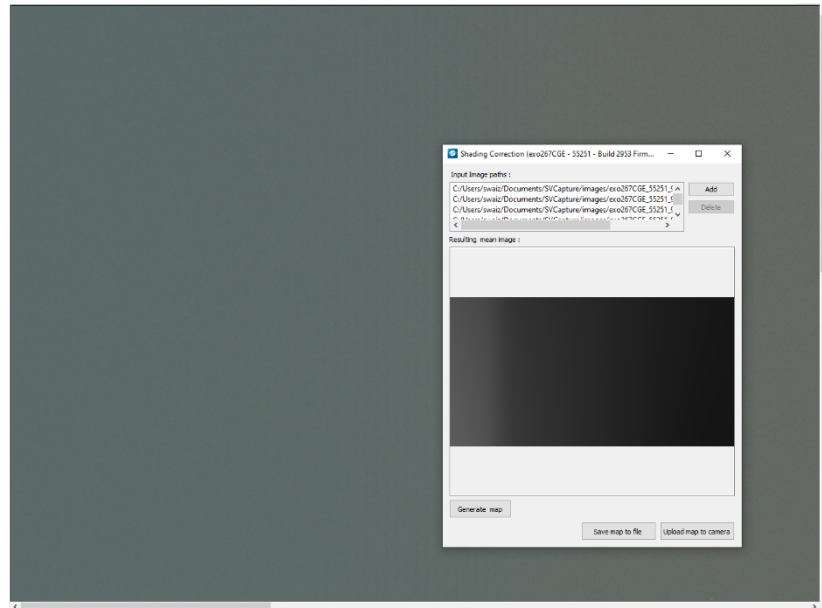

6.2.3 Defect pixel correction

All image sensor have defect pixels in a lesser or greater extent. Type and number of defects determine the quality grade (quality classification) of the sensor.

Defect Pixel Correction is using information from neighboring pixels to compensate for defect pixels or defect pixel clusters (cluster may have up to five defect pixels).

Defect Pixels either be dark pixels, i.e. that don't collect any light, or bright pixels (hot pixel) that always are outputting a bright signal.

The amount of hot pixels is proportional to exposure time and temperature of the sensor.

By default, all known defect pixels or clusters are corrected by SVS-VISTEK as a factory default.

Under challenging conditions or high temperature environments defect pixel behaviour might change. This can be corrected.

- A factory created defect map (SVS map), defying known defects, is stored in the camera.
- A custom defect map can be created by the user. A simple *.txt file with coordinates must be created. The user must locate the pixel defects manually.
- The *.txt file can be uploaded into the camera. Beware of possible Offset!
- Defect maps can be switched off to show all default defects, and switched back on to improve image quality.

Unlike shading correction, defect pixel correction suppresses single pixels or clusters and reconstructs the expected value by interpolating neighboring pixel values. The standard interpolation algorithm uses the pixel to the left or to the right of the defect. This simple algorithm prevents high runtime losses.

More sophisticated algorithms can be used by software.

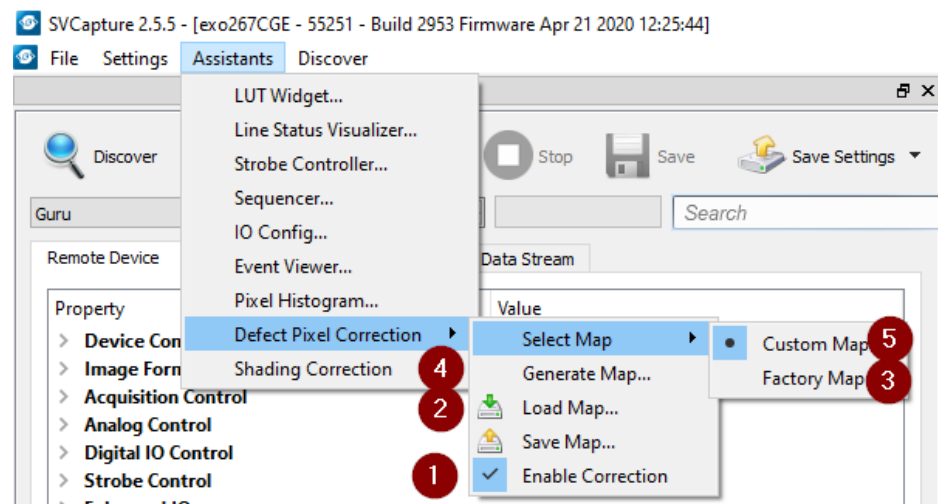

Fig.: 6-20: Illustration of a defect pixel

Procedure of pixel correction

SVCapture is the tool to generate pixel correction maps. The pixel correction assistant provides everything to create, load, enable and restore defect pixel creation maps.

Defect pixel correction is possible with certain models only. See camera specs whether your model does support this. In case your camera is not supporting, the assistant will not be selectable.



- For easy image processing, it is recommended to have pixel correction activated
- Pixel correction maps can be saved and loaded
- The std factory map can be selected any time
- Generate your own custom map
- Select your own defect pixel map

The procedure to create a std map is pretty straight forward. Before starting generating the map, in the GenICam tree do following:

- Set gain to 0 dB
- Disable autogain
- Set offset to 0
- Record a set of dark images (put lens cap on)

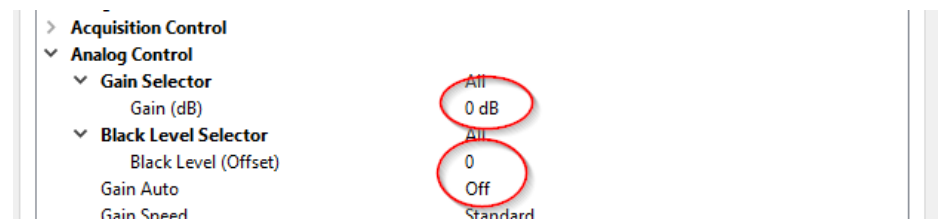

Defect pixel map generation

SVCapture defect pixel assistant requires a set of images being loaded

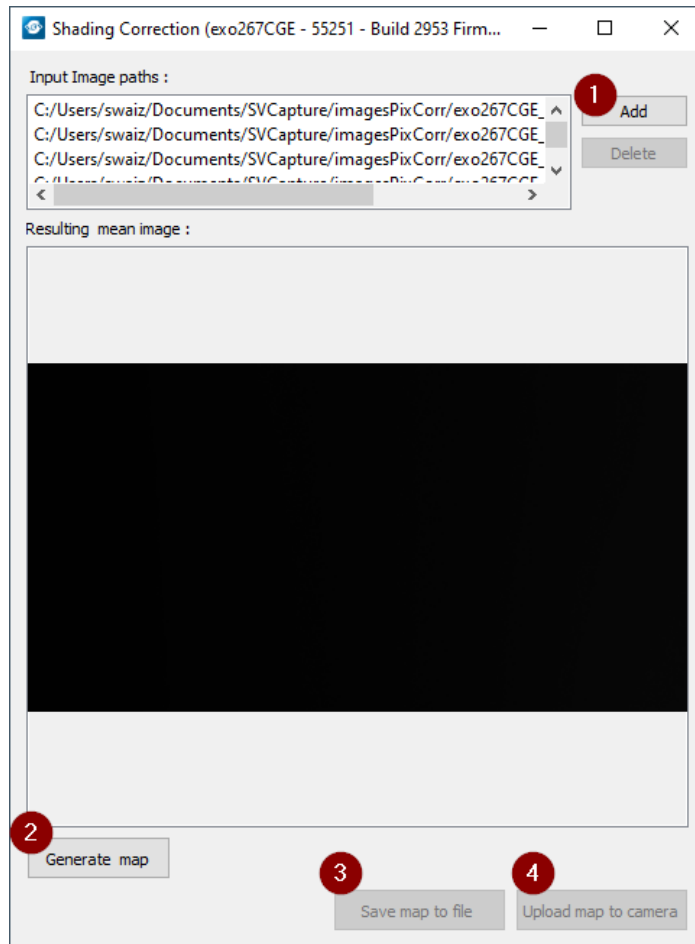

1. Load black images (16 images minimum) into generator
2. Generate map
3. Save map to file for later usage
4. Upload the map to the camera.

Make sure pixel correction is activated.

Procedure of pixel correction

SVCapture is the tool to generate pixel correction maps. The pixel correction assistant provides everything to create, load, enable and restore defect pixel creation maps.

Defect pixel correction is possible with certain models only. See camera specs whether your model does support this. In case your camera is not supporting, the assistant will not be selectable.

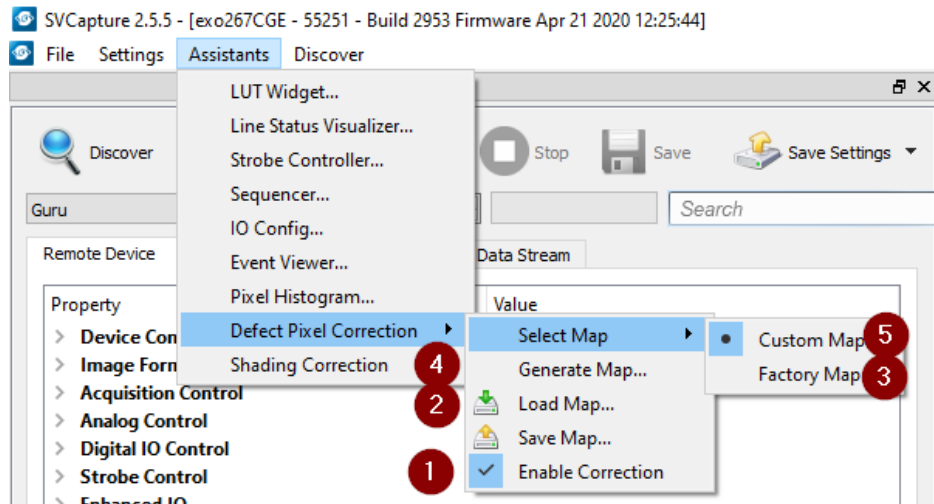

- For easy image processing, it is recommended to have pixel correction activated
- Pixel correction maps can be saved and loaded
- The std factory map can be selected any time
- Generate your own custom map
- Select your own defect pixel map

The procedure to create a std map is pretty straight forward. Before starting generating the map, in the GenICam tree do following:

- Set gain to 0 dB
- Disable autogain
- Set offset to 0
- Record a set of dark images (put lens cap on)

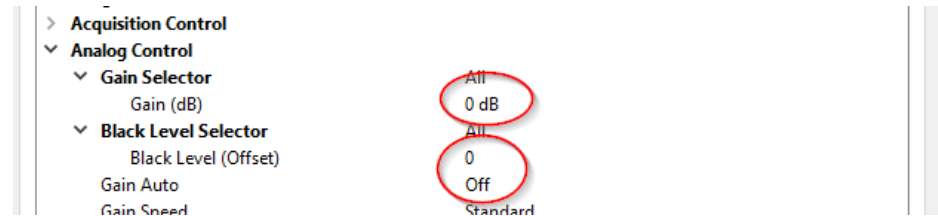

6.2.4 Look-up table

The look-up table feature (LUT) lets the user define certain values to every bit value that comes from the ADC. To visualize a LUT a curve diagram can be used, similar to the diagrams used in photo editing software.

The shown custom curve indicates a contrast increase by applying an S-shaped curve. The maximum resolution is shifted to the mid-range. Contrasts in this illumination range is increased while black values will be interpreted more black and more of the bright pixels will be displayed as 100 % white.

INFO

For further Information about curves and their impact on the image refer to our homepage: [Knowledge Base - LUT](#).

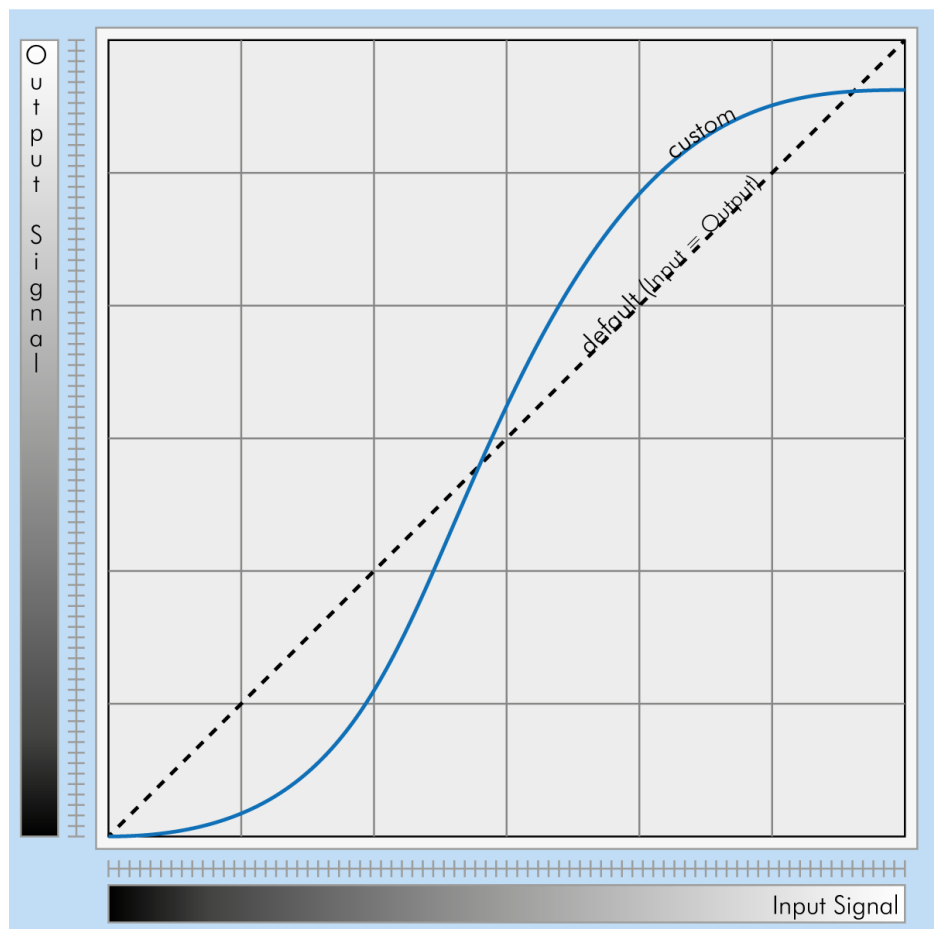

Fig.: 6-21: Custom LUT adding contrast to the mid-tones

INFO

LUT implementation reduces bit depth from 12 bit to 8 bit on the output.

Gamma correction

Using the look-up table makes it also possible to implement a logarithmic correction. This is commonly called “gamma correction”.

Historically gamma correction was used to correct the illumination behavior of CRT displays, by compensating brightness-to-voltage with a gamma value between 1,8 up to 2,55.

The gamma algorithms for correction can simplify resolution shifting as shown seen below.

- Input & output signal range from 0 to 1
- Output-signal = Input-signal^{Gamma}

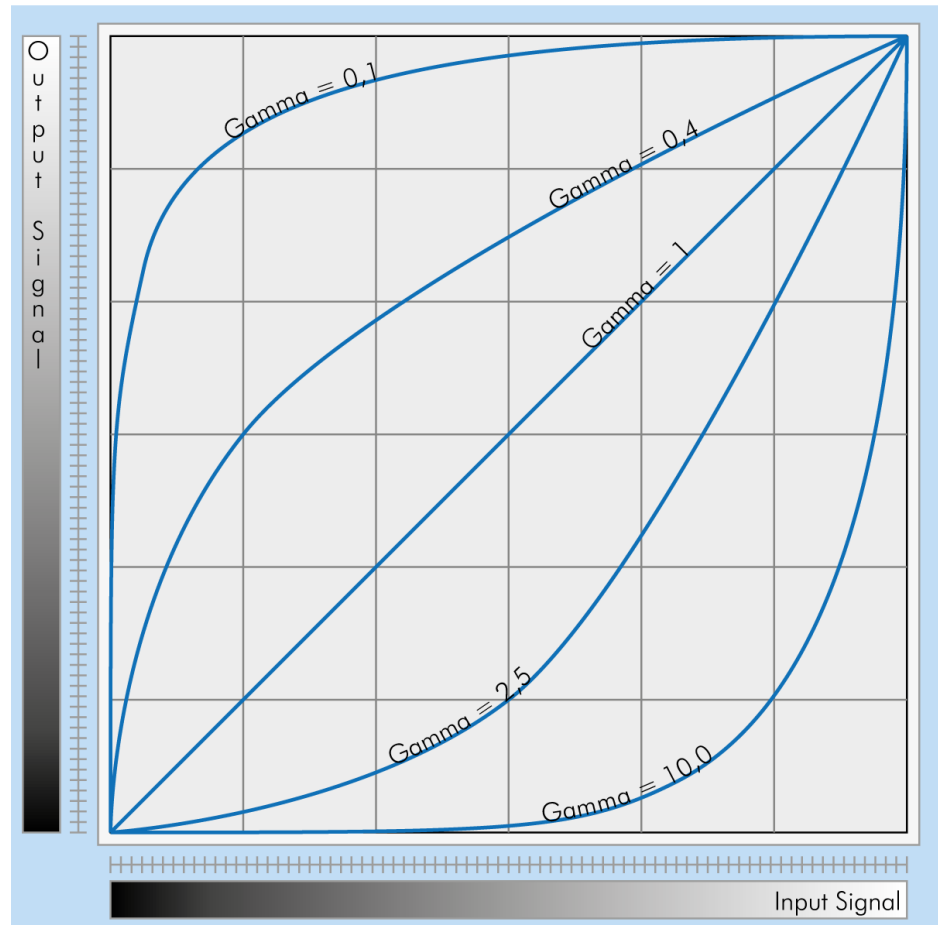

Fig.: 6-22: Several gamma curves comparable to a LUT

- Gamma values less than 1.0 map darker image values into a wider ranger.
- Gamma values greater than 1.0 do the same for brighter values.

INFO

Gamma algorithm is just a way to generate a LUT. It is not implemented in the camera directly.

6.2.5 ROI / AOI

In partial scan mode or Area-Of-Interest (AOI) mode (or Region-Of-Interest (ROI) mode) only a certain region of the sensor will be read.

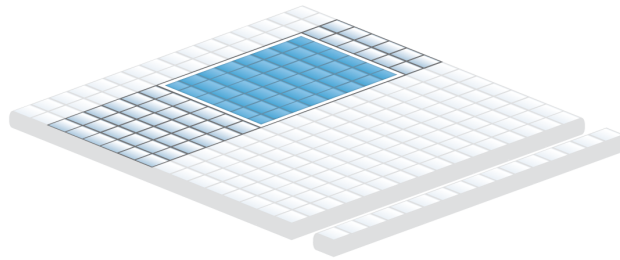

Fig.: 6-23: AOI on area sensor

Selecting an AOI will reduce the number of horizontal lines being read. This will reduce the amount of data to be transferred, thus increasing the maximum speed in terms of frames per second.

With CCD sensors, setting an AOI on the left or right side does not affect the frame rate, as lines must be read out completely.

With CMOS Sensors, AOI is sensor dependent. Some CMOS sensors require the camera to read full horizontal sensor lines internally. Reducing horizontal size with AOI might result in limited frame rate gain.

6.2.6 Basic capture modes

The camera has 2 basic operation modes.

- Free run (timed) run: The camera will expose and deliver images on a fixed schedule.
- Triggered: The camera will wait for an external signal and start exposure after receiving the external trigger signal.

Free running

Free running (fixed frequency) with programmable exposure time. Frames are readout continuously and valid data is indicated by LVAL for each line and FVAL for the entire frame.

There is no need to trigger the camera in order to get data. Exposure time is programmable via serial interface and calculated by the internal logic of the camera.

Mode 0: Free Running with Programmable Exposure Time

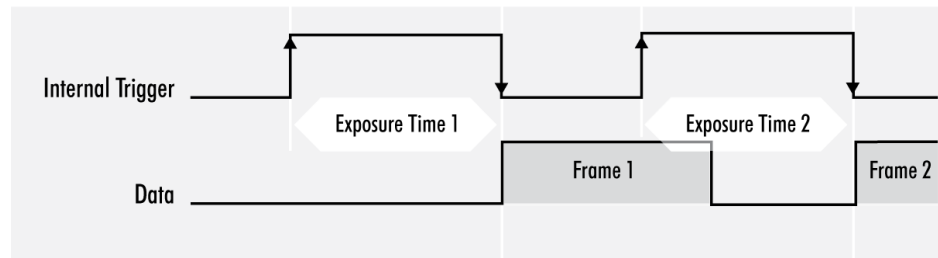

Fig.: 6-24: Basic capture modes - free running

The fundamental signals are:

- Line Valid: LVAL, Frame Valid: FVAL,
- And in case of triggered modes: trigger input.

Triggered mode (pulse width)

External trigger and pulse-width controlled exposure time. In this mode the camera is waiting for an external trigger, which starts integration and readout. Exposure time can be varied using the length of the trigger pulse (rising edge starts integration time, falling edge terminates the integration time and starts frame read out). This mode is useful in applications where the light level of the scene changes during operation. Change of exposure time is possible from one frame to the next.

Mode 1: External Trigger with Pulse Width Exposure Control (overlap)

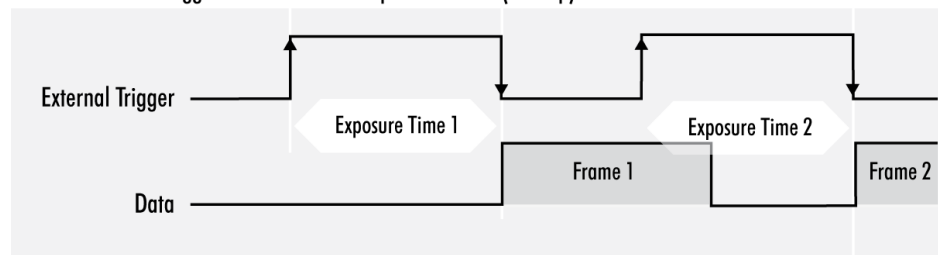

Fig.: 6-25: Basic capture modes - triggered mode (pulse width with overlap)

Exposure time of the next image can overlap with the frame readout of the current image (rising edge of trigger pulse occurs when FVAL is high). When this happens: the start of exposure time is synchronized to the falling edge of the LVAL signal.

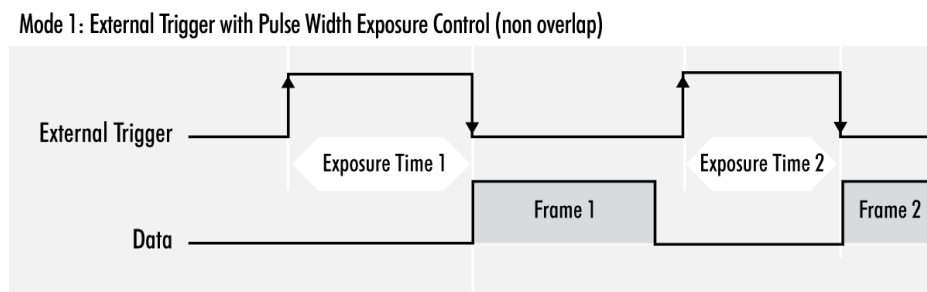

Fig.: 6-26: Basic capture modes - triggered mode (pulse width without overlap)

When the rising edge of trigger signal occurs after frame readout has ended (FVAL is low) the start of exposure time is not synchronized to LVAL and exposure time starts after a short and persistent delay.

The falling edge of the trigger signal must always occur after readout of the previous frame has ended (FVAL is low).

Software trigger

Trigger can also be initiated by software or serial interface.

INFO

Software trigger can be influenced by jitter. Avoid software trigger when using time sensitive applications.

6.2.7 Read-out control

Read-out control defines a delay between exposure and data transfer. Read-out control is used to program a delay value (time) for the readout from the sensor.

With more than one camera connected to a single computer, image acquisition and rendering can cause conflicts for data transfer, on CPU or bus system.

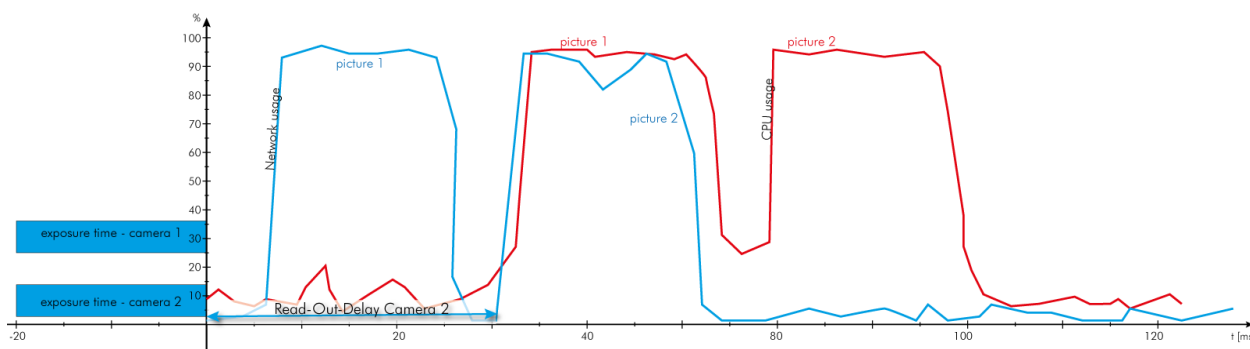

Fig.: 6-27: Illustration of physical data stream in time

6.2.8 Temperature sensor

A temperature sensor is installed on the main board of the camera. To avoid overheating, the temperature is constantly monitored and read. Besides software monitoring, the camera indicates high temperature by a red flashing LED (see flashing LED codes).

6.2.9 Fan control

The camera has a built-in fan that is set to automatic mode by default. The fan directs the airflow externally past the camera to avoid contamination inside the camera. The fan offers the following advantages:

- Small camera footprint (due to lack of large heat sinks) ensures easy integration
- Large temperature range in standalone operation
- Heat dissipation mainly through the thermo-mechanical connection of the housing
- Fan can be switched off if necessary. Ensure a good thermal connection to the camera housing.
- The fan activity mode can be set in the GenICam Tree.

Property	value
Device Control	
Vendor Name	SVS-VISTEK GmbH
Model Name	fxo540CXGE
Manufacturer Info	Build 3004 SVN 2965 May 25 2021 19:25:06
Device Version	1.7.2
Device ID	96789
Device User ID	
Device Scan Type	Area Scan
> Device Temperature Selector	Mainboard
> Device Clock Selector	Sensor
Device Reset	(command)
Device Link Throughput Limit Mode	Off
Device Link Throughput Limit	1000000000
Maximum Packets Resend	4095
LED Intensity	64
Fan Control	Auto
Fan Control Threshold	60 C

In the Fan Control area, the threshold value allows you to define the sensor temperature at which the fan becomes active in Auto mode (60°C default).

Device Control	
Vendor Name	SVS-VISTEK GmbH
Model Name	fxo540CXGE
Manufacturer Info	Build 3004 SVN 2965 May 25 2021 19:25:06
Device Version	1.7.2
Device ID	96789
Device User ID	
Device Scan Type	Area Scan
> Device Temperature Selector	Mainboard
> Device Clock Selector	Sensor
Device Reset	(command)
Device Link Throughput Limit Mode	Off
Device Link Throughput Limit	1000000000
Maximum Packets Resend	4095
LED Intensity	64
Fan Control	Auto
Fan Control Threshold	Off
> Image Format Control	On
	Auto

6.2.10 System clock frequency

Default system clock frequency in almost every SVCam is set to 66.6 MHz. To validate your system frequency refer to: specifications.

Using the system clock as reference of time, time settings can only be made in steps. In this example, the transfer rate is 66.7 MHz, thus resulting in steps of 15 ns.

$$t = \frac{1}{66.6 \text{ MHz}} = \frac{1}{66\,666\,666.6 \frac{1}{s}} = 15 \cdot 10^{-9} \text{ s} = 15 \text{ ns}$$

INFO

Use multiples of 15 ns to write durations into camera memory.

6.2.11 Predefined configurations (user sets)

The camera starts with default values for all features when turned on. Settings made during operation will expire when the camera is turned off.

All preset adjustments are located in the GenICam tree in the “User Set Control” property. It is possible to save up to 8 user sets. Each of these setups consists of a complete configuration set including exposure time, delays, I/O configuration for the camera. These user sets can be loaded at runtime. In addition, you can specify which setup is loaded as default when the camera is switched on.

Load a user set

With UserSetSelector a user set can be selected. Select the desired user set and press UserSetLoad (command) twice to load the user set. The following example loads user set 2.

▼ User Set Control	
▼ UserSetSelector	User Set 2
UserSetLoad	(command)
UserSetSave	(command)
User Set Default	User Set 5

Save user sets

Select the user set to be saved in the UserSetSelector and save it with the UserSetSave command.

▼ User Set Control	
▼ UserSetSelector	User Set 2
UserSetLoad	(command)
UserSetSave	(command)
User Set Default	User Set 5

Set a user set as default

Use User Set Default to select the user set that is to be loaded when the camera is started. Save this setting with UserSetSave (In the example below, user set 5 is saved as default).

▼	UserSetSelector	User Set 2
	UserSetLoad	(command)
2	UserSetSave	(command)
1	User Set Default	User Set 5

Reset to factory default

User sets can be reset to factory settings. This is a two-step process. First, the factory settings must be loaded:

▼	User Set Control	
1	▼	UserSetSelector
2	UserSetLoad	(command)
	UserSetSave	(command)
	User Set Default	Default User Set

Afterwards this factory default user set must be saved again as user set (in the example below, user set 2 is overwritten with the factory settings).

▼	User Set Control	
	▼	UserSetSelector
	UserSetLoad	(command)
	UserSetSave	(command)
	User Set Default	User Set 5

6.2.12 Particle Image Velocimetry

Cameras operated in Particle Image Velocimetry (PIV) mode will generate 2 consecutive images with ultra-short gap between 2 exposures. PIV mode uses specific sensor modes and has to be activated in the GenICam tree.

▼	Acquisition Control	
	Acquisition Mode	Continuous
	Acquisition Start	(command)
	Acquisition Stop	(command)
	▼	Trigger Selector
	Trigger Mode	Off
	Generate Software Trigger	(command)
	Trigger Source	Trigger Software
	Trigger Activation	Rising Edge
	Trigger Delay	0 us
	Sensor Trigger Mode	PIV
	Sensor Shutter Mode	TriggerOverlap
	Exposure Mode	PIV

Sony IMX Pregius S sensors minimum gap is approx. 1-2 μ s. 1st image exposure time has to be adjusted like in normal camera operation, with restrictions depending on resolution and bit depth. 2nd image exposure time is readout time for 1st image and cannot be adjusted.

On trigger signal, first image is exposed. The sensor itself will trigger 2nd exposure right after finishing 1st exposure, the gap is not adjustable. Finally, you will get 2 images.

Particle Image Velocimetry (PIV) Mode Readout

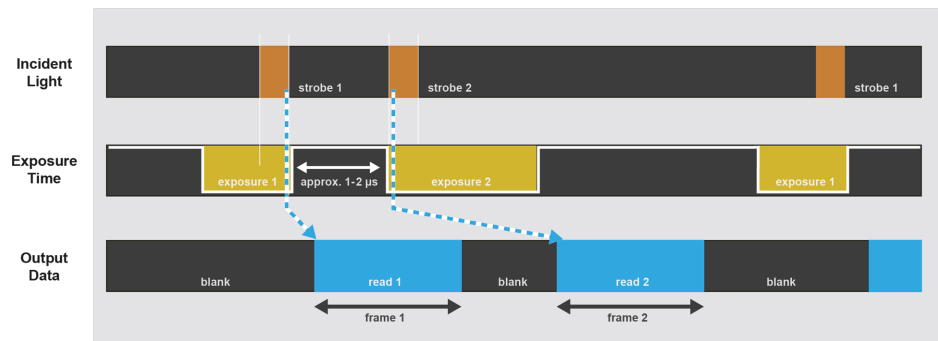

Fig.: 6-28: Sequence of exposure in PIV mode

For avoiding different image brightness as a result of different exposure times of both images, it is recommended to work in darkness and control image brightness via strobe light intensity and strobe duration.

Gap adjustment is done by positioning strobe in the exposure windows. For getting ultra-short exposure gaps, 1st strobe is at the end of 1st exposure time and 2nd strobe is at beginning of second exposure.

Readout of 1st frame is while 2nd frame being exposed.

6.3 I/O Features

The SVCam cameras are equipped with several inputs and outputs, providing state-of-the-art control regarding input and output channels. All I/O functions are realized as modules. These functions can be connected in the GenICam tree.

6.3.1 GenICam

GEN<i>CAM provides a generic programming interface to control all kinds of cameras and devices. Regardless of the interface technology (GigE Vision, USB3 Vision, CoaXPress, Camera Link, etc.) or implemented feature, the application programming interface (API) will always be the same. The SNFC makes sure the feature names are similar throughout the manufacturers, making it more easy to switch camera models.

The GenICam™ standard consists of multiple modules according to the main tasks to be solved:

- GenApi: configuring the camera
- SNFC: Standard Feature Naming Convention, a catalog of standardized names and types for common device features
- GenTL: transport layer interface, grabbing images
- GenCP: generic GenICam control protocol
- GenTL SFNC: recommended names and types for transport layer interface.

The GenICam properties are organized as a tree. Manufacturers can add more features.

With your SVCam, the GenICam tree does have some hardware related extensions, especially in the I/O sector. See the Quick guide install for a short introduction into the SVS-Vistek GenICam tree.

The GenICam properties are organized in views. The recommended way to view and adjust is by using SVCapture. If you want to have a full view of all adjustable GenICam items, activate the Guru mode. Beginner mode will show only most common attributes.

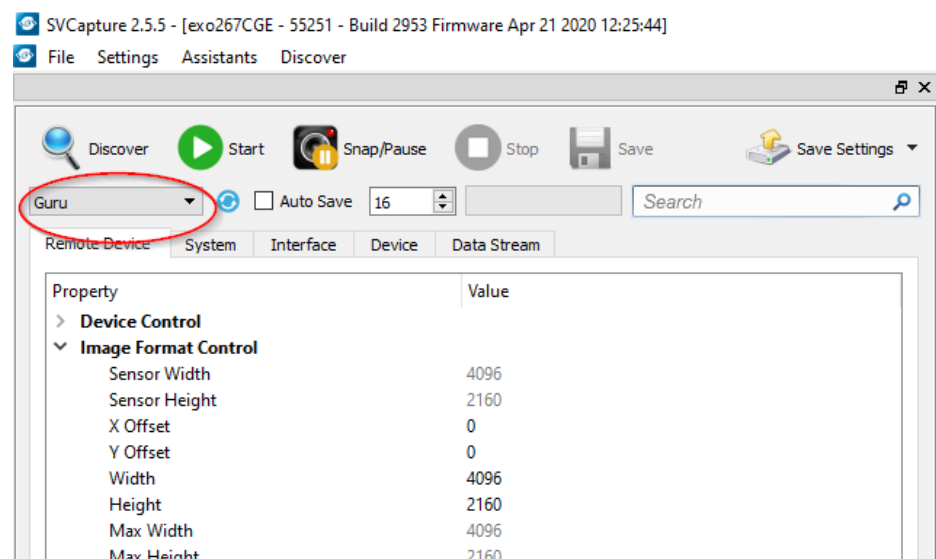

NOTICE All modifications in the GenICam tree will have immediate effect.

6.3.2 Assigning I/O Lines - IOMUX

The IOMUX is best described as a switch matrix. It connects inputs, and outputs with the various functions of SVCam I/O. It also allows combining inputs with Boolean arguments.

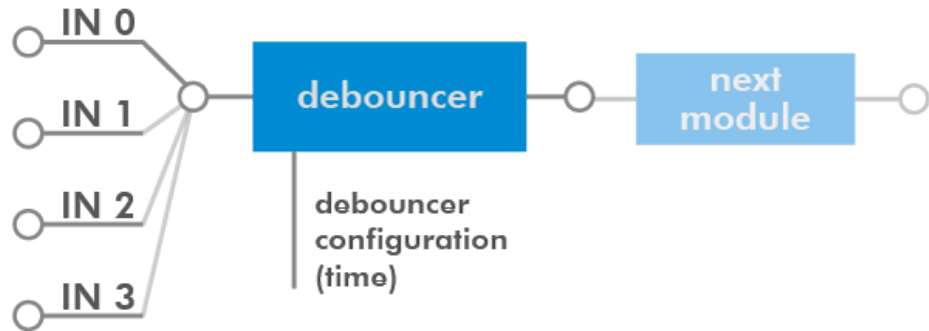

Fig.: 6-29: "IN0" connected to "debouncer"

Now the debounced signal can be taken from Debouncer (line 8) in the next module as source.

LineSelector	Translation
Line0	Output0
Line1	Output1
Line2	Output2
Line3	Output3
Line3	Output4
Line5	Uart In
Line6	Trigger
Line7	Sequencer
Line8	Debouncer
Line9	Prescaler
Line10	Input0
Line11	Input1
Line12	Input2
Line13	Input3
Line14	Input4
Line15	LogicA
Line16	LogicB
Line17	LensTXD

LineSelector	Translation
Line18	Pulse0
Line19	Pulse1
Line20	Pulse2
Line21	Pulse3
Line22	Uart2 In

The input and output lines for Strobe and Trigger impulses can be arbitrarily assigned to actual data lines. Individual assignments can be stored persistently to the EPROM. Default setting can be restored from within the Camera.

INFO

Refer to pin-out in input / output connectors when physically wiring.

Input vector to switch matrix

No.	Name	Description
0	io_in(0)	trigger input 0 - 24 Volt / RS-232 / opto *
1	io_in(1)	trigger input 0 - 24 Volt / RS-232 / opto *
2	io_in(2)	trigger input 0 - 24 Volt / RS-232 / opto *
3	io_in(3)	trigger input 0 - 24 Volt / RS-232 / opto *
4	io_rxd	input
5	txd_from_uart1	input
6	strobe(0)	output from module iomux_pulseloop_0
7	strobe(1)	output from module iomux_pulseloop_1
8	rr_pwm_out_a	output from module iomux_sequenzer_0
9	rr_pwm_out_b	output from module iomux_sequenzer_0
10	expose	input
11	readout	input
12	r_sequenzer_pulse_a	output from module iomux_sequenzer_0 (pulse)
13	rr_pwm_out_c	output from module iomux_sequenzer_0
14	rr_pwm_out_d	output from module iomux_sequenzer_0
15	r_sequenzer_active	output from module iomux_sequenzer_0
16	r_debouncer	output from module iomux_dfilter_0
17	r_prescaler	output from module iomux_prescaler_0
18	r_sequenzer_pulse_b	output from module iomux_sequenzer_0 (pwm_mask)
19	r_logic	output from module iomux_logic_0
20	strobe(2)	output from module iomux_pulseloop_2
21	strobe(3)	output from module iomux_pulseloop_3
22	mft_rxd	input
23	trigger_feedback	input
24	txd_from_uart2	input

* refer to pinout or specifications

Output vector from switch matrix

No.	Name / register	Description
0	io_out(0)	output open drain
1	io_out(1)	output open drain
2	io_out(2)	output open drain *
3	io_out(3)	output open drain *
4	io_txd	output, when debug='0'
5	rxd_to_uart1	output (uart_in)
6	trigger	output
7	sequenzer_hw_trigger	input to module iomux_sequenzer_0
8	debounce input	input to module iomux_dfilter_0
9	prescale input	input to module iomux_prescaler_0
10	logic inputa	input to module iomux_logic_0
11	logic inputb	input to module iomux_logic_0
12	mft_txd	output
13	pulseloop_hw_trigger	input to module iomux_pulseloop_0
14	pulseloop_hw_trigger	input to module iomux_pulseloop_1
15	pulseloop_hw_trigger	input to module iomux_pulseloop_2
16	pulseloop_hw_trigger	input to module iomux_pulseloop_3
17	rxd_to_uart2	output (uart2_in)

INFO

For physical number of open drain outputs refer to pinout or specifications.

Example of an IOMUX configuration

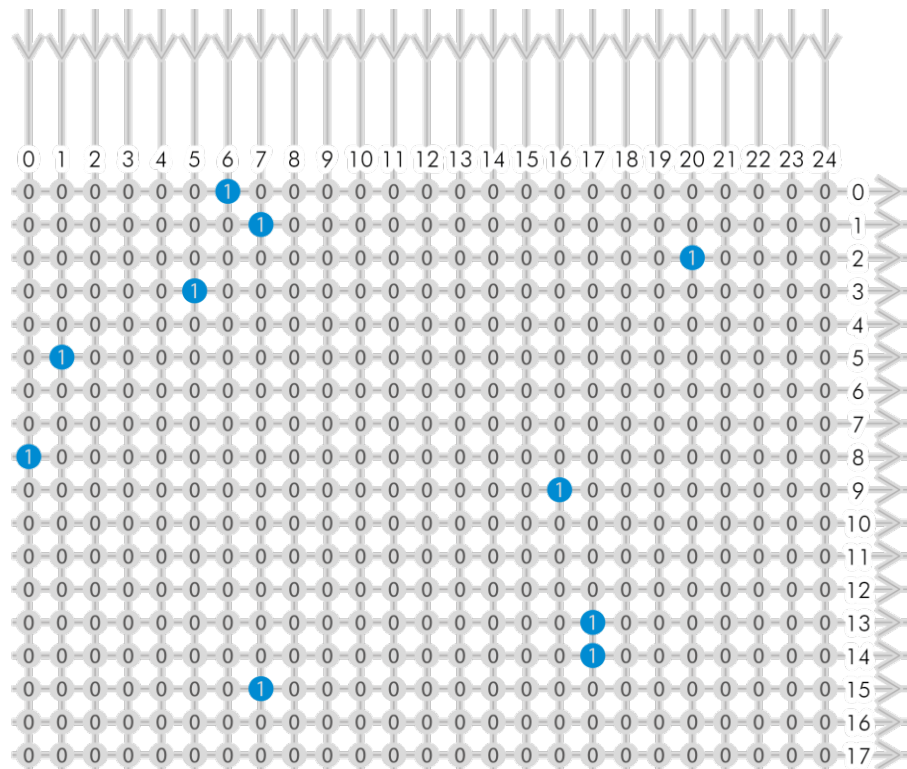

Fig.: 6-30: Example of an IOMUX configuration

- The trigger signal comes in on line 0
- Debounce it.
connect line 0 to 8:
10000000000000000000000000000000
signal appears again on line 15 - debouncer out
- Use the prescaler to act only on every second pulse.
connect line 16 to 9.
0000000000000000000000001000000000
signal appears again on line 17 - debouncer out
- Configure a strobe illumination with pulseloop module 0
connect line 17 to 13
signal from pulse loop module 0 appears on line 6
connect line 6 to 0 (output 0)
- Set an exposure signal with pulseloop module 1.
connect line 17 to 6
- Tell another component that the camera is exposing the sensor.
connect line 17 to 14
signal from pulse loop module 1 appears on line 7
connect line 7 to 1 (output 1)
- Turn of a light that was ON during the time between two pictures.
connect line 17 to 15
invert signal from pulse loop module 2
it appears on line 20
connect line 20 to 2 (output 2)

Inverter

The inverter enabled at a certain line provides the reverse signal to or from a module.



Set to “1”

With set to “1” enabled in a certain line, this line will provide a high signal no matter what signal was connected to the line before.

Set to “1” - inverse

The inverse of a set to “1” line will occur as a low signal, regardless of the actual signal that enters the inverter module.

Easy overview with the I/O assistant

The easiest approach for an overview of current I/O connections is to use the I/O assistant of SVCapture. Every function or module has a source.

IO Config(exo267CGE - 55251 - Build 2953 Firmware Apr 21 2020 12:25:44)

Mode	Line	Inv	Source	Status
Output	Output 0 - Line0	<input type="checkbox"/>	Off	
Output	Output 1 - Line1	<input type="checkbox"/>	Strobe 0	
Output	Output 2 - Line2	<input type="checkbox"/>	Off	
Output	Output 3 - Line3	<input type="checkbox"/>	Off	
Output	Output 4 - Line4	<input type="checkbox"/>	Off	
Output	Uart In - Line5	<input type="checkbox"/>	Off	
Output	Trigger - Line6	<input type="checkbox"/>	Logic	
Output	Sequencer - Line7	<input type="checkbox"/>	Off	
Output	Debouncer - Line8	<input type="checkbox"/>	Input 1	
Output	Prescaler - Line9	<input type="checkbox"/>	Off	
Output	Logic A - Line15	<input type="checkbox"/>	Debouncer	
Output	Logic B - Line16	<input type="checkbox"/>	Input 2	
Output	Lens TXD - Line17	<input type="checkbox"/>	Off	
Output	Pulse 0 - Line18	<input type="checkbox"/>	Triggerfeedback	
Output	Pulse 1 - Line19	<input type="checkbox"/>	Triggerfeedback	

I/O assistant of SVCapture with activated debouncer and logic input

With the example above

- Input 1 will be debounced at first
- Then input 1 is combined via logic module with the logic value of input 2
- The logic result signal finally is the input for trigger.

NOTICE This assistant view is showing the module connection only. The properties of each module are visible in std GenICam view only (e.g. what kind of logic operation)

6.3.3 PWM

During Pulse Width Modulation (PWM), a duty cycle is modulated by a fixed frequency square wave. This describes the ratio of ON to OFF as duty factor or duty ratio.

Why PWM?

Pulse width modulation is an extremely efficient way (in terms of power dissipation) to provide/regulate electrical power to consumers as long as they do not need uninterrupted supply (such as diodes or LEDs). The interruption times might be as short as nano seconds.

LED characteristics

Since LEDs have a bounded workspace, the PWM ensures a variable intensity of illumination at a constant current on the diodes. The constant current guarantees a linear light emission response curve of the LED from 0-100% PWM intensity.

Running LED lighting in flash mode will increase LED lifetime because of reduced LED heat dissipation.

Implementation of PWM

The basic frequency of the modulation is defined by the cycle duration "T".

$$T_{PWM} = \frac{1}{f_{PWM}}$$

Duty cycle "T" is written into the registry by multiple of the inverse of camera frequency in 15 ns steps (refer to ["System clock frequency" on page 59](#)).

$$T_{PWM} = \frac{1}{66,6MHz} \cdot PWMMax[SeqSelector] = 15 ns \cdot PWMMax[SeqSelector]$$

The intensity of a PWM

The duty ratio is calculated as: $\Delta\% = t / T$. It is written above the value of "t" as PWMChange0-3[SeqSelector] per sequence into the registry.

PWMChange0-3[SeqSelector] unit is percentage value.

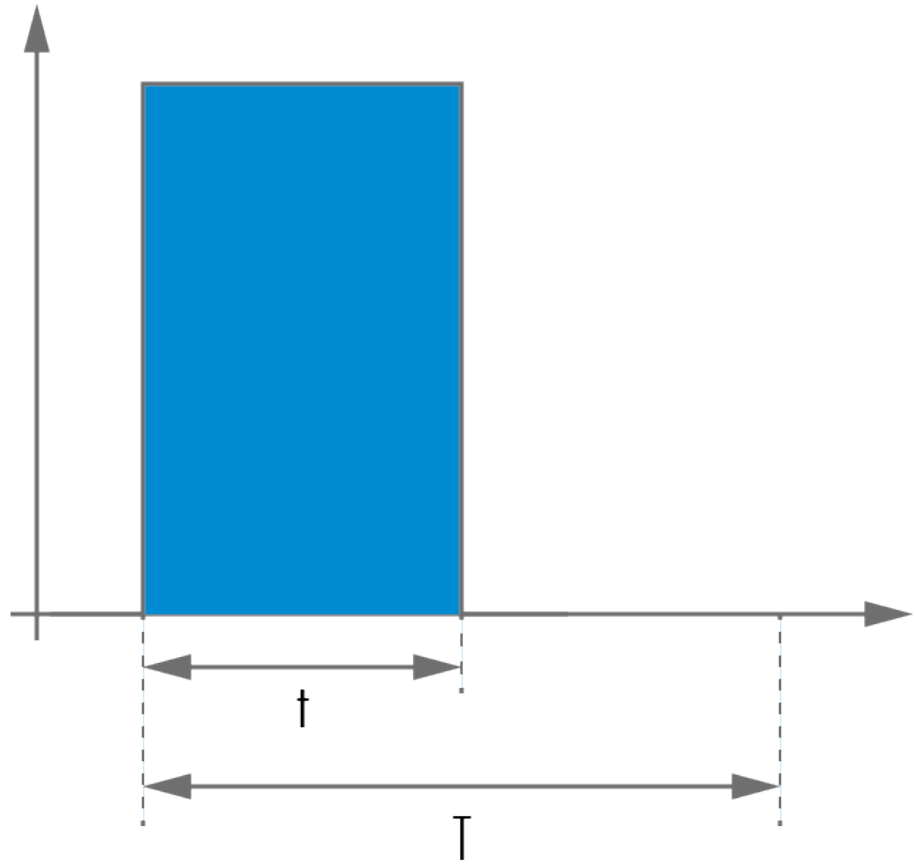

Fig.: 6-31: PWM intensity

Examples of PWMs

The integrals over both periods T_A and T_B are equal.

$$\int_{t_{A1}}^{t_{A2}} \mathbf{A} = \int_{t_{B1}}^{t_{B2}} \mathbf{B}$$

An equal amount of Photons will be emitted. The intensity of light is the same.

$$t_{A2} - t_{A1} = t_{B2} - t_{B1}$$

The periods T_A and T_B are equal in length.

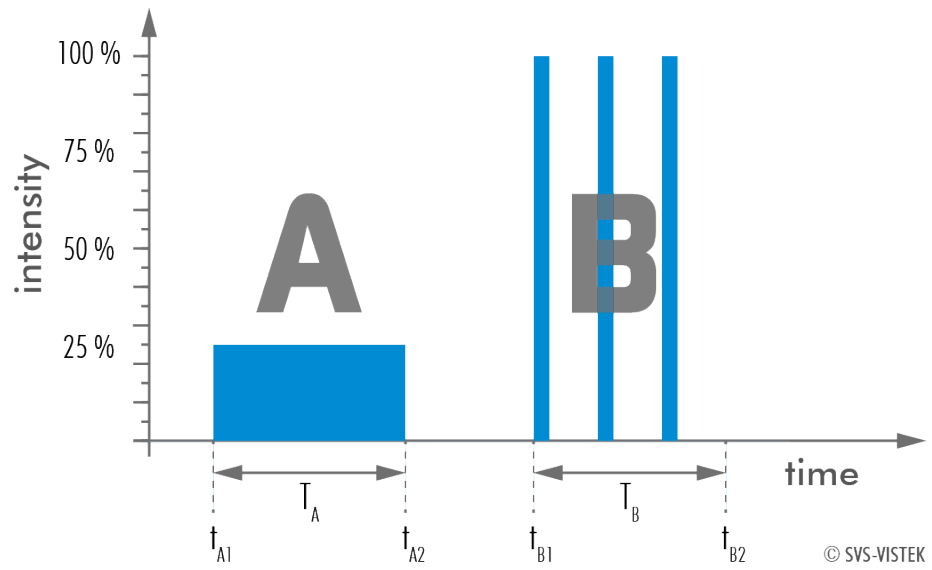

Fig.: 6-32: Example: 25% PWM load

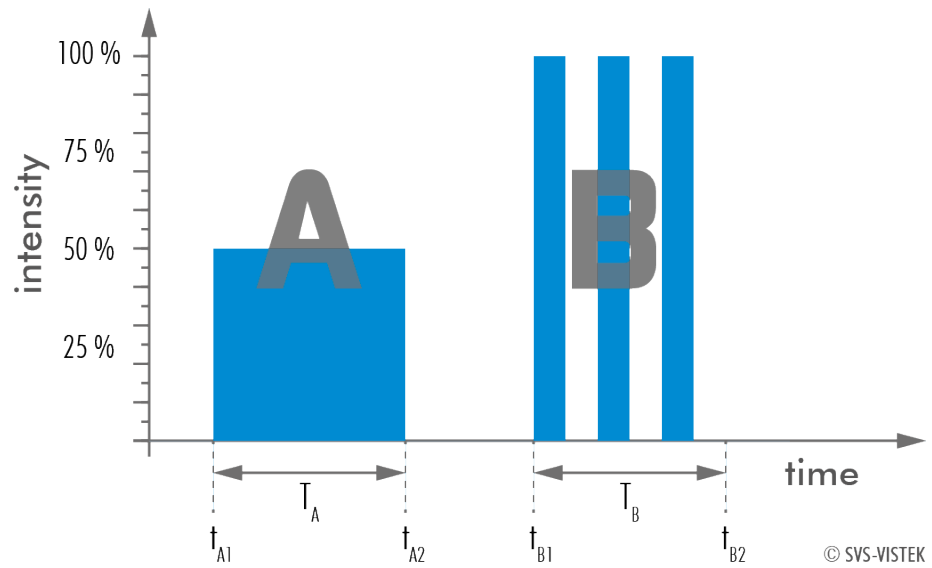

Fig.: 6-33: Example: 50% PWM load

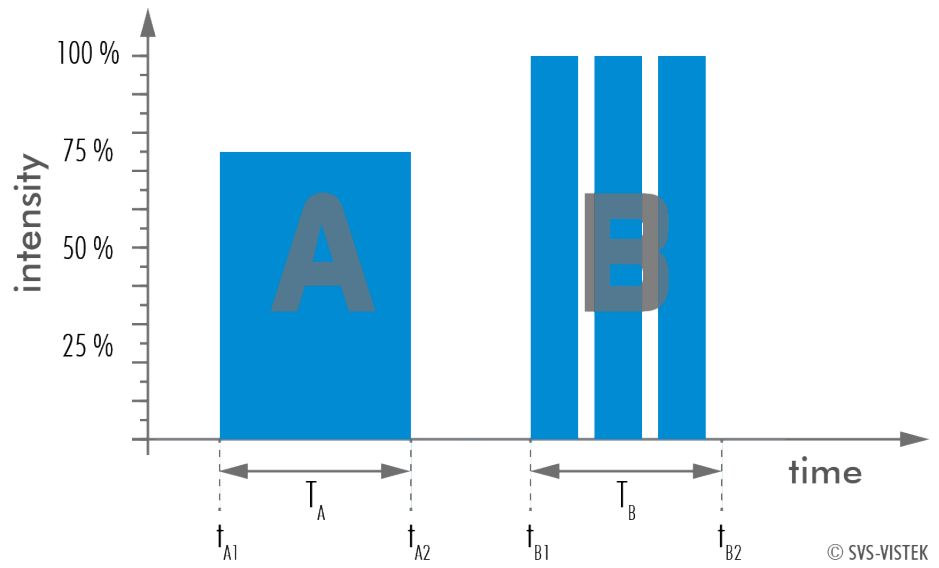

Fig.: 6-34: Example: 75% PWM load

The PWM module

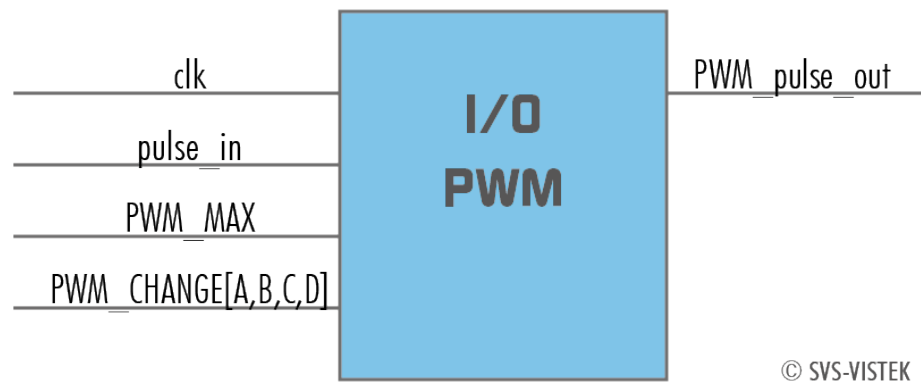

Fig.: 6-35: The PWM module

6.3.4 LED strobe control

The SVCam 4I/O concept contains an integrated strobe controller. Its controls are integrated into the GenICam tree. With LED lights attached to the outputs, this enables the user to control the light without external devices. Being controlled via GenICam, any GenICam-compliant 3rd party software is able to control the light as well. Maximum ON-time is 100ms. Depending on the camera model, up to 4 (see specifications) independent channels are supported with a max current of 3A@40ms 1A@40ms. Maximum continuous current is 0.3 A. Despite internal protections, higher current peaks might be able to damage the camera.

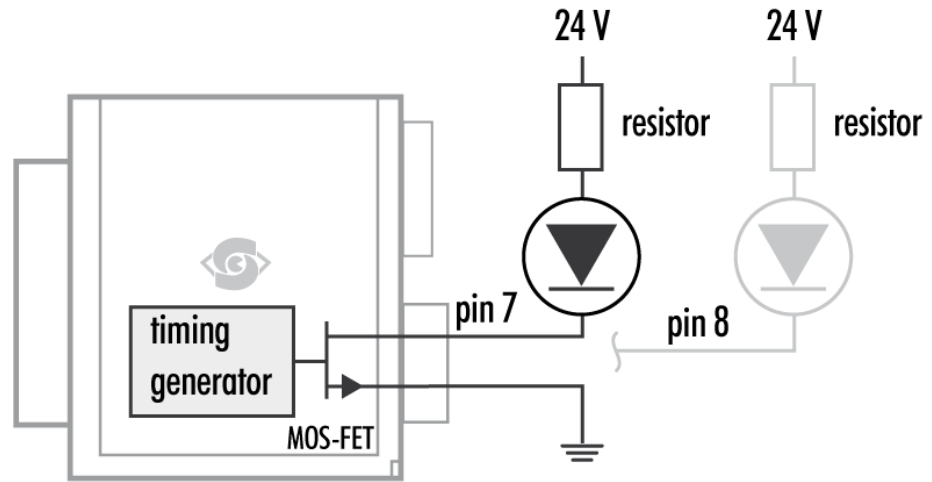

Fig.: 6-36: Attach LED lights to camera outputs

NOTICE To avoid destruction of your LED light or camera, make sure to use the right dimension of shunt resistor. If not done so, LEDs and/or Camera might be damaged.

Calculate LED shunt resistors

Shunt resistors are used to limit the LED current. Make sure, neither shunt nor LED run above specs.

LEDs in continuous mode

Voltage drop at 5 LEDs, 2,2V per LED (see spec. of LED)	11 V
Max. continuous current (see spec. of LED)	250 mA
Voltage supply	24 V
Voltage drop at resistor (24 V - 11 V)	13 V
Pull up Resistor $R = \frac{13 V}{250 mA}$	52 Ω

Table: 6-2: LEDs in continuous mode

Total power ($P = U \times I$)	6 W
Power at LEDs ($11 V \times 250 mA$)	2,75 W
Power loss at resistor ($13 V \times 250 mA$)	3,25 W

Table: 6-3: Example Calculation “No Flash” (CW Mode)

LEDs in flash mode

Most LED lights can cope with currents higher than specs. This gives you higher light output when light is ON. Refer to your LED specs if LED overdrive is permitted.

By controlling the duty cycle the intensity of light and current can be controlled. See sequencer example how to adjust the values in the GenICam tree for strobe control.

INFO

The shorter the „time on“ - the higher current can be used when driving LEDs with current higher than spec

As a rule of thumb, make sure your PWM lighting frequency is at least double or triple the bit-depth of your image (e.g. 8 bit image = 256, this means your PWM has to be switched at least $256 \times 2 = 512$ times) while exposing. If exposure time is 5 ms, the required minimum PWM freq = $5 \text{ ms} / 512 \sim 10 \mu\text{s} \sim 100 \text{ kHz}$.

Strobe vocabulary

For an example how to enable and adjust the integrated strobe controller refer to sequencer (see ["Sequencer" on the next page](#)). Times and frequencies are set in tics. 1 tic = 15 ns.

Exposure delay

A tic value, representing the time between the (logical) positive edge of trigger pulse and start of integration time.

Strobe polarity

Positive or negative polarity of the hardware strobe output can be selected.

Strobe duration

The exposure time of LED lights can be set in tics. The min duration is 1 μs . The longest time is 1 second.

Strobe delay

The delay between the (logical) positive edge of trigger pulse and strobe pulse output.

6.3.5 Sequencer

The sequencer is used when different exposure settings and illuminations are needed in a row.

Values to set	Description
Sequencer interval	Duration of the interval
Exposure start	Exposure delay after interval start
Exposure stop	Exposure stop related to interval Start
Strobe start	Strobe delay after interval start
Strobe stop	Strobe stop related to interval Start
PWM frequency	Basic duty cycle (1 / Hz) for PWM
PWM change	Demodulation results

In the current GenICam implementation, all values have to be entered in tic values.

1 tic = 15 ns

Every adjustment (times, frequencies) has to be recalculated into tics and done in tics. See the example below.

When setting “Exposure Start” and “Stop” consider ‘read-out-time’ of the sensor. It has to be within the Sequencer interval.

For physical input and output connections refer to pin-out or specifications or see example below. After trigger signal all programmed intervals will start. Up to 16 intervals can be programmed.

Sequencer settings can be saved to camera EEPROM.

Example

For demonstration, imagine following task to be done:

Scenario

An object should be inspected with a monochrome camera. For accentuating different aspects of the image, 4 images should be taken in a row with 4 different colours of light: Red, Green, Blue, White. White light should be generated from the RGB lights being activated at the same time. Basis is a dark environment without other light sources.

Camera wiring

- 3 LED lights are physically connected to the camera on out 0-2 (red, green, blue)
- Out 3 is not used

I/O matrix

- 4 images to be taken (RGBW) result in 4 sequences
- RGB PWM change with different intensities (duty cycle) taking care for differences in spectral response of the camera sensor
- PWM change 0-2 is connected to out 0-2
- Seq pulse A is driving the exposure (trigger)
- Seq pulse B is driving the strobe
- Seq pulse B in WHITE sequence is reduced down to 33% as light intensities of 3 lights (RGB) will add up

Notes

- Different exposure / strobe timings are used for illustration. In most cases they will show values same as exposure
- The resulting exposure time shows the period of sensor light exposure. ("masking" of exposure time by creating strobe light impulses shorter than exposure time). This value is not adjustable at the camera
- PWM change is shown with reduced height for demonstrating reduced intensity. In reality though, PWM change will be full height (full voltage, shunt resistor might be necessary) with the adjusted duty cycle
- Use a PWM frequency high enough not to interfere with your timings (here: 1000 Hz)

Scenario values	Interval 0 (RED)	Interval 1 (GREEN)	Interval 2 (BLUE)	Interval 3 (WHITE)
Sequencer Interval	1000 ms	1000 ms	1000 ms	1000 ms
Seq pulse A start	0 ms	0 ms	100 ms	0 ms
Seq pulse A stop	100 ms	300 ms	300 ms	100 ms
Seq pulse B start	0 ms	100 ms	200 ms	0 ms
Seq pulse B stop	100 ms	200 ms	300 ms	33 ms
PWM Frequency f	1000 Hz	1000 Hz	1000 Hz	1000 Hz
PWM change 0 (RED)	100%	0%	0%	100%
PWM change 1 (GREEN)	0%	70%	0%	70%
PWM change 2 (BLUE)	0%	0%	80%	80%
PWM change 3	-	-	-	-

As stated before, all these values have to be entered into the camera's GenICam tree as tic values.

The timing values translate like this into tics:

Values to set in GenICam properties	Interval 0 (RED)	Interval 1 (GREEN)	Interval 2 (BLUE)	Interval 3 (WHITE)
Sequencer Interval	6666667 tic (1000 ms)	6666667 tic (1000 ms)	6666667 tic (1000 ms)	6666667 tic (1000 ms)
Seq pulse A start	0 tic (0 ms)	0 tic (0 ms)	666667 tic (100 ms)	0 tic (0 ms)
Seq pulse A stop	6666667 tic (100 ms)	2000000 tic (300 ms)	2000000 tic (300 ms)	6666667 tic (100 ms)
Seq pulse B start	0 tic (0 ms)	666667 tic (100 ms)	1333333 tic (200 ms)	0 tic (0 ms)
Seq pulse B stop	6666667 tic (100 ms)	1333333 tic (200 ms)	2000000 tic (300 ms)	2200000 tic (33 ms)
Effective exposure time	100 ms	100 ms	100 ms	33 ms
PWM Frequency f	6667 tic (1000 Hz)	6667 tic (1000 Hz)	6667 tic (1000 Hz)	6667 tic (1000 Hz)
PWM change 0 (RED)	6667 tic (100% of 1000 Hz)	0 tic	0 tic	6667 tic (100% of 1000 Hz)
PWM change 1 (GREEN)	0 tic	4667 tic (70% of 1000 Hz)	0 tic	4667 tic (70% of 1000 Hz)
PWM change 2 (BLUE)	0 tic	0 tic	5333 tic (80% of 1000 Hz)	5333 tic (80% of 1000 Hz)
PWM change 3	-	-	-	-

In a timings diagram, the sequence values above will look like the following diagram.

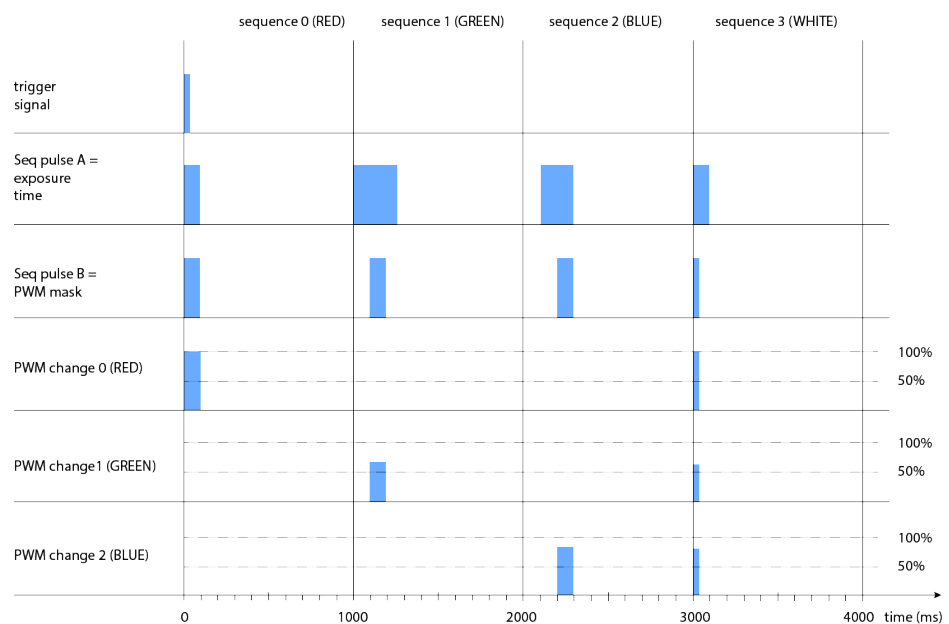
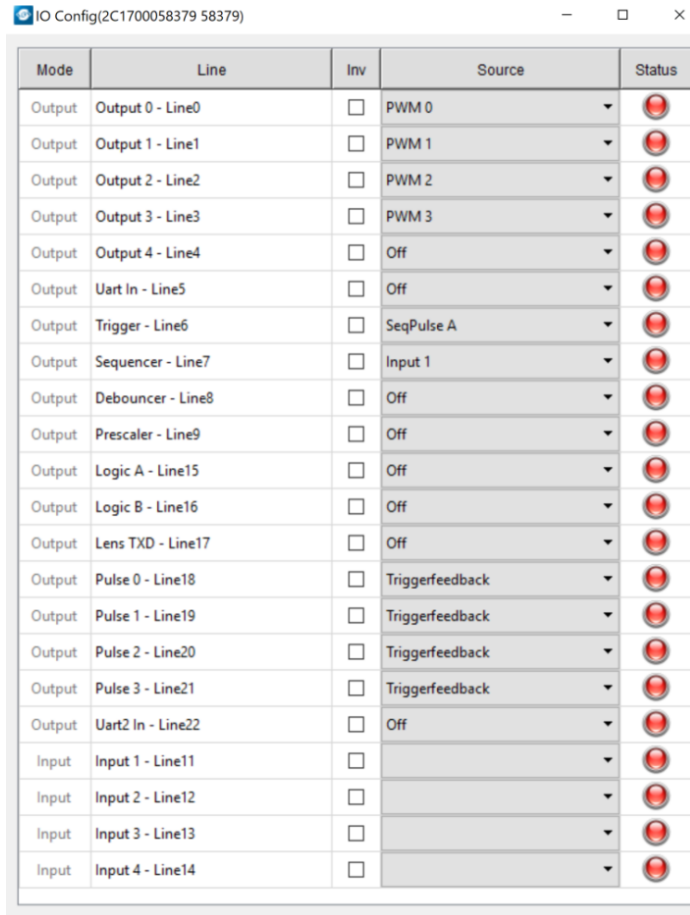

Fig.: 6-37: Sequencer timing diagram

Sequencer setup with SVCapture

Starting with SVCapture 2.5.2, there is a sequencer assistant, providing easy setup of the sequencer settings. The assistant will help you to setup timings for start exposure and lighting and so on. The PWMs are connected to the physical outputs (e.g. for driving LED lights)..

For making the sequencer work in general, have a look into the GenICam tree or even more simple into the I/O assistant. Connect the I/O lines as below.



The screenshot shows a window titled "IO Config(2C1700058379 58379)" with a table of I/O line configurations. The table has five columns: Mode, Line, Inv, Source, and Status. Each row represents a different I/O line, with its mode, name, inversion status, source, and a status indicator (a red circle with a white dot).

Mode	Line	Inv	Source	Status
Output	Output 0 - Line0	<input type="checkbox"/>	PWM 0	●
Output	Output 1 - Line1	<input type="checkbox"/>	PWM 1	●
Output	Output 2 - Line2	<input type="checkbox"/>	PWM 2	●
Output	Output 3 - Line3	<input type="checkbox"/>	PWM 3	●
Output	Output 4 - Line4	<input type="checkbox"/>	Off	●
Output	Uart In - Line5	<input type="checkbox"/>	Off	●
Output	Trigger - Line6	<input type="checkbox"/>	SeqPulse A	●
Output	Sequencer - Line7	<input type="checkbox"/>	Input 1	●
Output	Debouncer - Line8	<input type="checkbox"/>	Off	●
Output	Prescaler - Line9	<input type="checkbox"/>	Off	●
Output	Logic A - Line15	<input type="checkbox"/>	Off	●
Output	Logic B - Line16	<input type="checkbox"/>	Off	●
Output	Lens TXD - Line17	<input type="checkbox"/>	Off	●
Output	Pulse 0 - Line18	<input type="checkbox"/>	Triggerfeedback	●
Output	Pulse 1 - Line19	<input type="checkbox"/>	Triggerfeedback	●
Output	Pulse 2 - Line20	<input type="checkbox"/>	Triggerfeedback	●
Output	Pulse 3 - Line21	<input type="checkbox"/>	Triggerfeedback	●
Output	Uart2 In - Line22	<input type="checkbox"/>	Off	●
Input	Input 1 - Line11	<input type="checkbox"/>		●
Input	Input 2 - Line12	<input type="checkbox"/>		●
Input	Input 3 - Line13	<input type="checkbox"/>		●
Input	Input 4 - Line14	<input type="checkbox"/>		●

You may start the sequence with a hardware trigger input signal (sequencer is connected to Input 1). As an alternative you might use a software trigger. For software trigger setup, adjust as below:

Feature name	Feature value
Acquisition Control - Acquisition Mode	Continuous
Acquisition Control - Trigger Selector - Trigger Mode	On
Acquisition Control - Trigger Selector - Trigger Source	Line 1
Acquisition Control - Trigger Selector - Exposure Mode	Trigger Width
Enhanced IO - PWMEnable	On
Enhanced IO - SeqEnable	On

The Exposure mode „trigger width“ makes exposure start at a certain timing (Seq pulse A) and stop at Seq pulse B. In the GenICam tree this will reflect as following:

The screenshot shows the GenICam software interface with the following configuration details:

- Acquisition Control**
 - Acquisition Mode: Continuous
 - Trigger Selector: Acquisition Start
 - Trigger Mode: On
 - Generate Software Trigger: (command)
 - Trigger Source: Line 1
 - Trigger Activation: Rising Edge
 - Trigger Delay: 0 us
 - Exposure Mode: Trigger Width
 - Acquisition Frame Rate: 10 Hz
 - Exposure Time: 99871 us
 - Exposure Auto: Off
 - Exposure First: Off
 - ExposureTimeMin: 1000 us
 - ExposureTimeMax: 300000 us
 - Sensor Shutter Mode: Global Shutter
- Enhanced IO**
 - PWMEnable: On
 - SeqTrigger: (command)
 - SeqTriggermode: Trigger on high level
 - SeqSelector: 3
 - SeqInterval: 6700000
 - SeqPulseAStart: 0
 - SeqPulseAStop: 6666666
 - SeqPulseBStart: 0
 - SeqPulseBStop: 6666666
 - PWMMax: 66666
 - PWMChange0: 0
 - PWMChange1: 0
 - PWMChange2: 0
 - PWMChange3: 66666
 - SeqCount: 4
 - SeqEnable: On
 - SeqLoop: Off
 - DebounceDuration: 66666
 - PrescaleDivisor: 2

6.3.6 Optical input

In many trigger signals you find noise, transients and voltage spikes. These are able to damage components in the camera and trigger signal interpretation might be difficult.

An optical input separates the electrical trigger and camera circuits. The benefit of such an optical input is to avoid all these kinds of interaction from power sources or switches. The disadvantage of an optical input is that it is slower in terms of signal transmission and slew rate than a direct electrical connection.

If you need super fast response from the camera, direct electrical access is your choice. If your camera trigger is in the ms range or slower, we recommend to use the optical input.

An optical input needs some current for operation. The SVS-Vistek optical input is specified to 5-24 V, 8 mA.

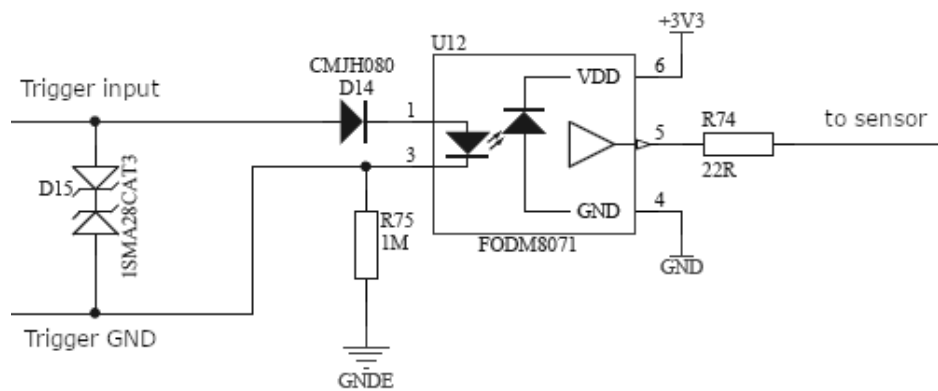

Fig.: 6-38: Optical input

The optocoupler galvanically separates electrical circuits by emitting light on one side and interpreting light in the other. There is no direct electric interaction between both electrical circuits.

6.3.7 PLC / Logical operation on inputs

The logic input combines trigger signals with Boolean algorithms. The camera provides AND, NAND, OR, NOR, XOR, XNOR as below. You might combine true/false states of the inputs to determine camera actions. The result can be connected to a camera trigger signal or it may be source for the next logical operation with another input. It is possible to connect it to an OUT line as well.

Do it in the GenICam tree

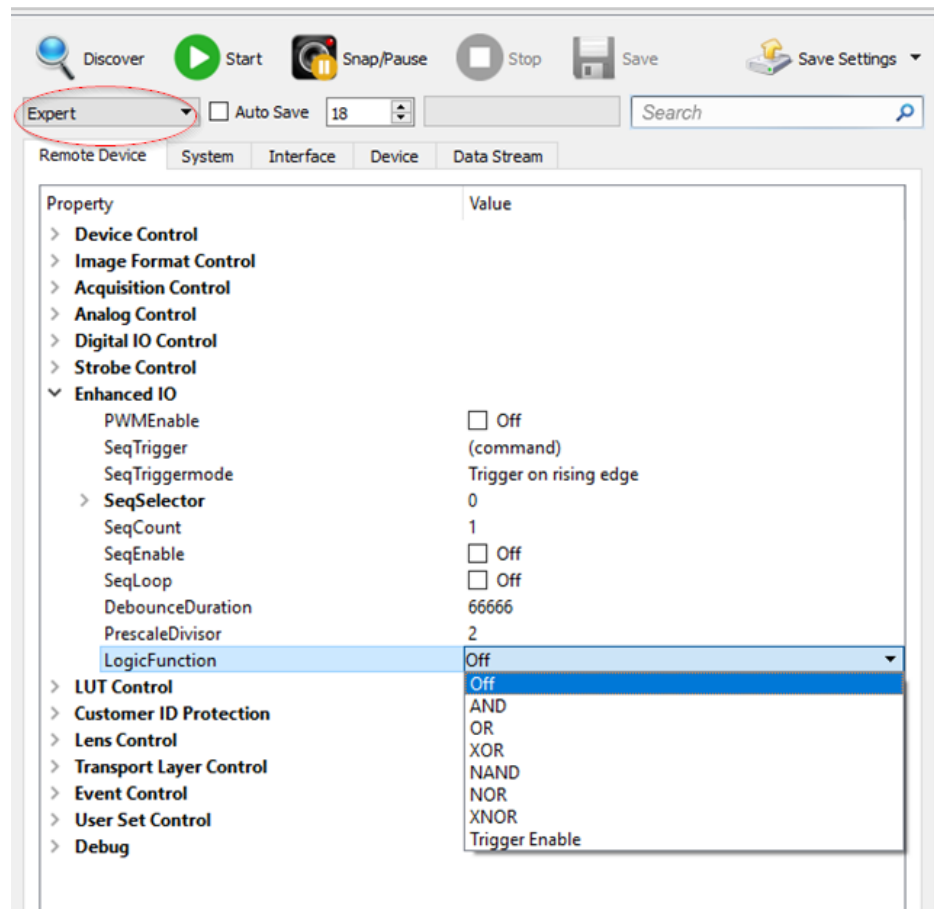

The logic function always combines the values of Digital IO InputA/LogicA and InputB/LogicB. In case of the Trigger enable logic function, LogicB is the trigger enable signal and will be combined with LogicA value.

AND	NAND	OR	NOR	XOR	XNOR
A B Y	A B Y	A B Y	A B Y	A B Y	A B Y
0 0 0	0 0 1	0 0 0	0 0 1	0 0 0	0 0 1
0 1 0	0 1 1	0 1 1	0 1 0	0 1 1	0 1 0
1 0 0	1 0 1	1 0 1	1 0 0	1 0 1	1 0 0
1 1 1	1 1 0	1 1 1	1 1 0	1 1 0	1 1 1

Table: 6-4: Truth table of logic function

NOTICE Expert view of the GenICam tree has to be activated to see logic functions.

6.3.8 Serial data interfaces

(ANSI EIA/ TIA-232-F

RS-232 and RS-422 (from EIA, read as Radio Sector or commonly as Recommended Standard) are technical standards to specify electrical characteristics of digital signaling circuits. Serial connection might be used to control SVCams. These signals are used to send low-power data signals to control exposure, light or lenses (MFT). Usage scenario is a control possibility without network. Be aware of low connection speed.

Serial interface parameter	RS-232	RS-422
Maximum open-circuit voltage	±25 V	±6 V
Max differential voltage	25 V	10 V
Min. signal range	±3 V	2 V
Max. signal range	±15V	10 V

Table: 6-5: Serial interface parameters - RS-232 and RS-422

INFO

See your camera data sheet regarding its serial capabilities.

Data transport is always asynchronous. Synchronization is implemented by first and last bit of a package. Data rate (bits per second) must be defined before transmission.

RS232

RS232 is split into 2 lines receiving and transferring data.

- RXD: receive data
- TXD: transmit data

Signal voltage values are:

- Low: -3 ... -15 V
- High: +3 ... +15 V

INFO

For restrictions, refer to table of serial interface parameter above.

Packaging data into containers (adding start and stop bits) is implemented by the UART (Universal Asynchronous Receiver Transmitter).

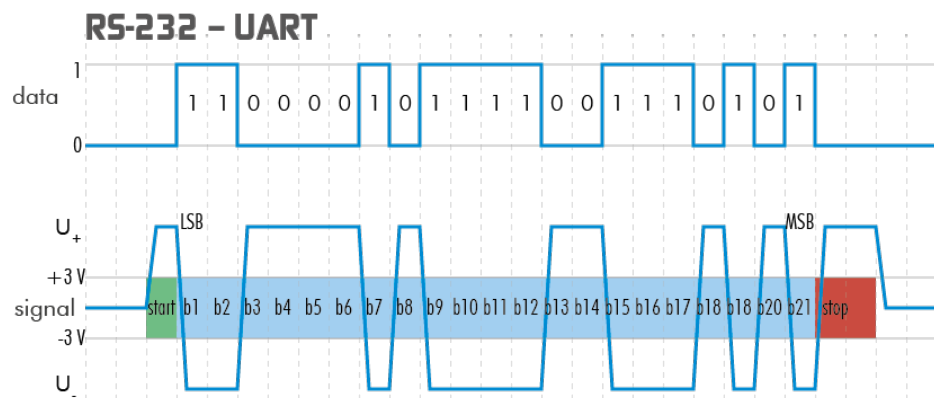

Fig.: 6-39: UART encoding of a data stream

6.3.9 Trigger-edge sensitivity

Trigger-edge sensitivity is implemented by a “Schmitt trigger”. Instead of triggering to a certain value, the Schmitt trigger provides a threshold.

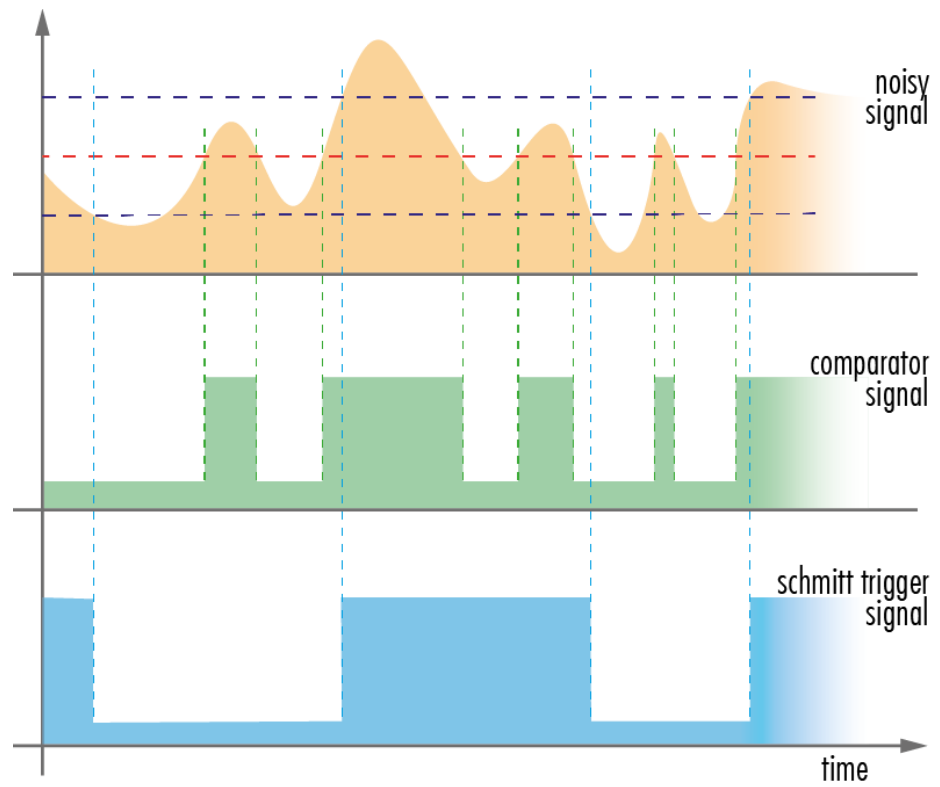

Fig.: 6-40: Schmitt trigger noise suppression

6.3.10 Debouncing trigger signals

Bounces or glitches caused by a switch can be avoided by software within the SVCam.

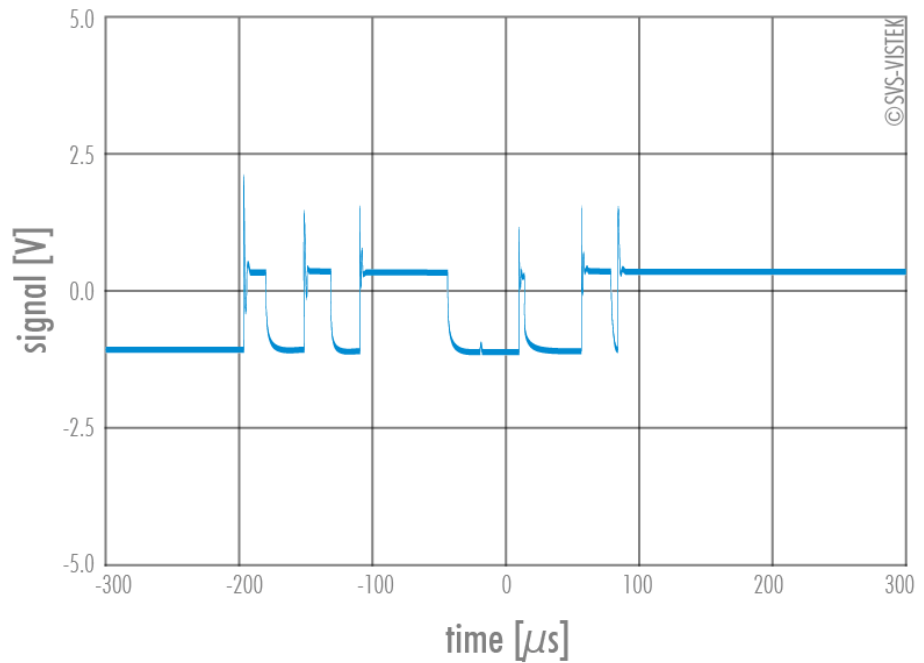

Fig.: 6-41: Bounces or glitches caused by a switch

Therefore the signal will not be accepted until it lasts at least a certain time.

- ▶ Use the IO Assignment tool to place and enable the debouncer module in between the “trigger” (Schmitt trigger) and the input source (e.g.: line 1).

The “DebounceDuration” register can be set in multiples of 15 ns (implement of system clock), e.g. 66 666 \approx 1 ms

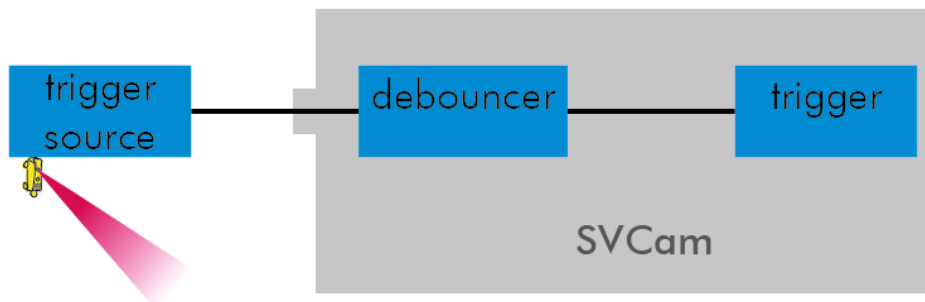

Fig.: 6-42: Debouncer between the trigger source and trigger

> Anaio Control	
> Digital IO Control	
> LineSelector	Debounce - Line8
LineMode	Output
LineInverter	<input type="checkbox"/> Off
LineStatus	<input type="checkbox"/> Off
LineSource	Input 1
LineStatusAll	0x1400039000000000
> UserOutputSelector	UserOutput 0
UserOutputValueAll	0
UserOutputValueAllMask	31
UseroutputStatusLevel	CamStatus_undefined
UseroutputStatusMask	0
> Strobe Control	
> Enhanced IO	
PWMEnable	<input type="checkbox"/> Off
SeqTrigger	(command)
SeqTriggermode	Trigger on rising edge
> SeqSelector	0
SeqCount	1
SeqEnable	<input type="checkbox"/> Off
SeqLoop	<input type="checkbox"/> Off
DebounceDuration	66666
PrescaleDivisor	2
LogicFunction	AND
> LUT Control	
> Customer ID Protection	

Input 1 debounce time here is about 1 ms.

The debouncer module

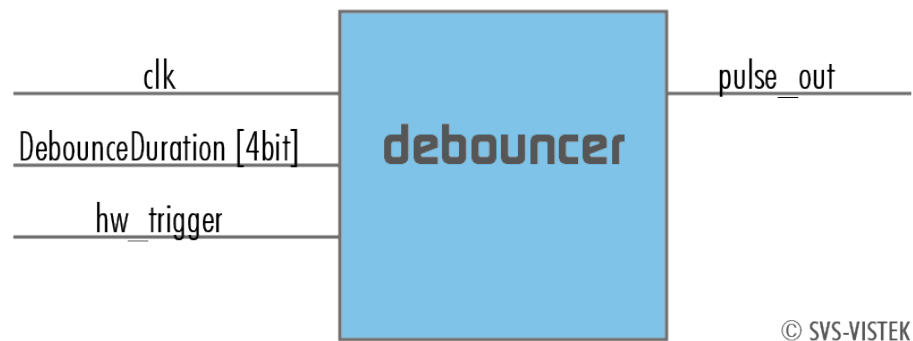

Fig.: 6-43: The debouncer module

6.3.11 Prescale

The Prescale function can be used for masking off input pulses by applying a divisor with a 4-bit word, resulting in 16 unique settings.

- Reducing count of interpreted trigger signal
- Use the prescale function to ignore a certain count of trigger signals.
- Divide the amount of trigger signals by setting a divisor.
- Maximum value for prescale divisor: is 16 (4 bit)

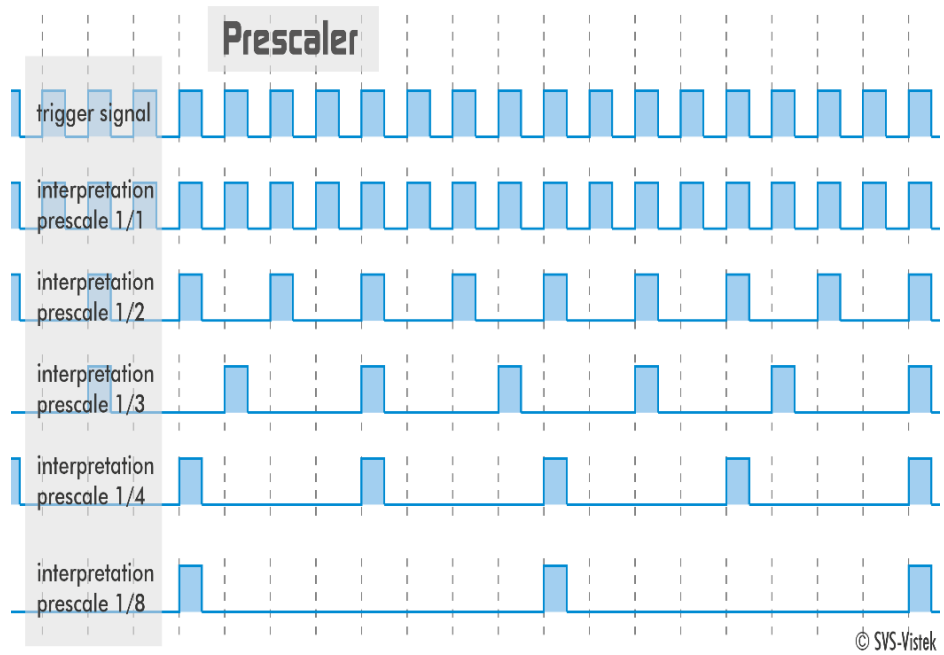

Fig.: 6-44: Prescale values and their result on trigger signal

The prescale module

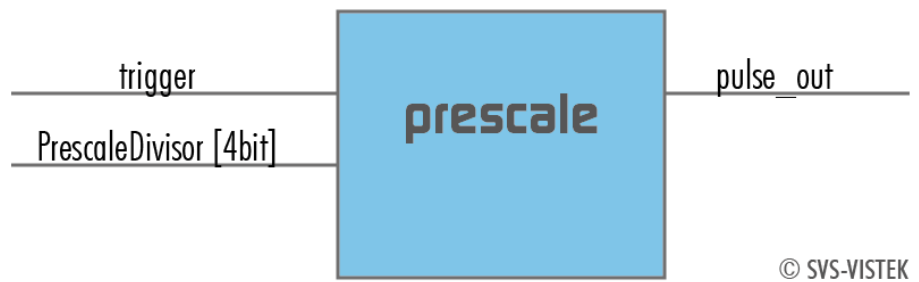

Fig.: 6-45: The prescale module

7 Dimensions

INFO

All length units in mm.

Find the technical drawings in the web download area at

<https://www.svs-vistek.com/en/support/svs-support-download-center.php>

CAD step files available with valid login at [SVS-VISTEK.com](https://www.svs-vistek.com)

7.1 C-mount

C-mount back focus distance from sensor to lens is 17.526 mm. The camera is fitted with a standard C-mount threading.

- Diameter: 1 inch
- Screw threading: 1/32 inch

C-mount cameras only accept C mount lenses as the flange to sensor distance does not allow a CS mount lens close enough to the Sensor to achieve a focused image.

Optical path length is calculated including IR or dust protection glass. Removing the glass will affect optical path length.

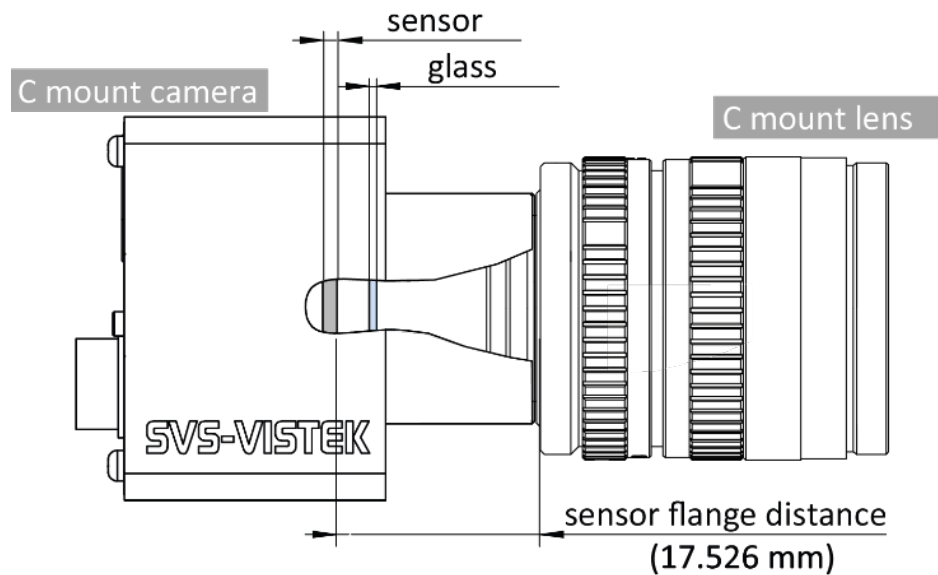
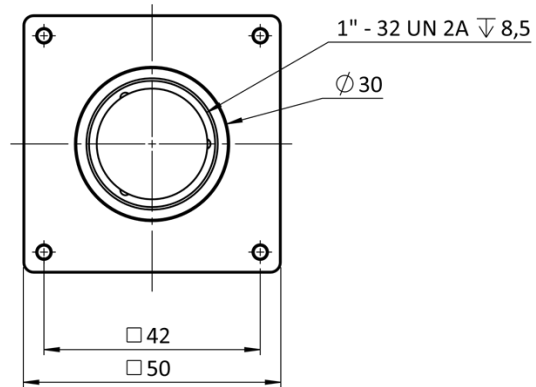

Fig.: 7-1: C-mount

7.2 fxo540, fxo541, fxo542, fxo545, fxo546, fxo547

front



back

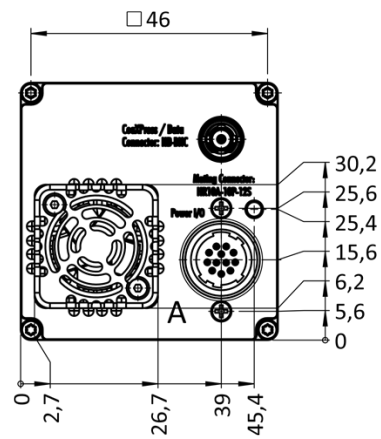

top

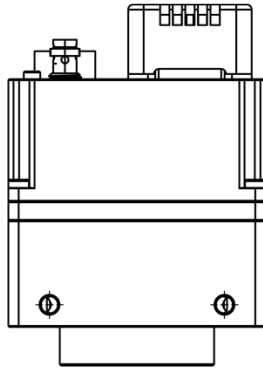

bottom

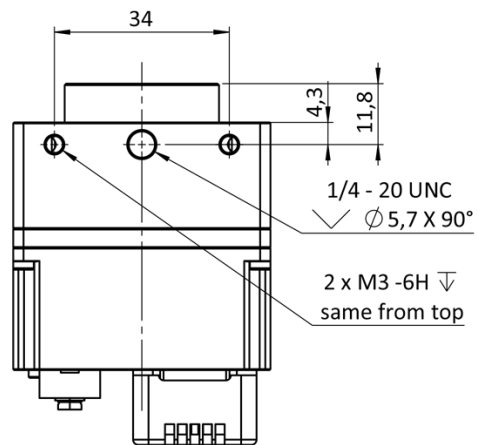

right side

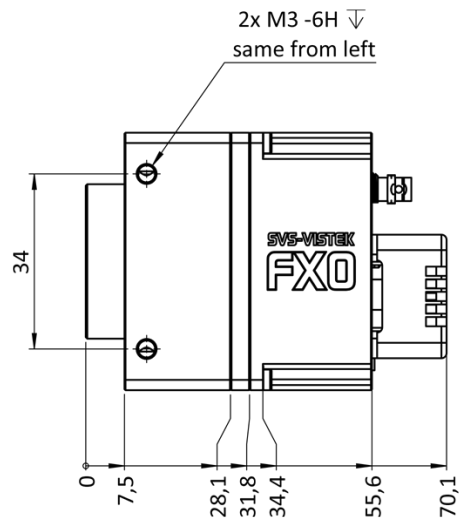

cross section

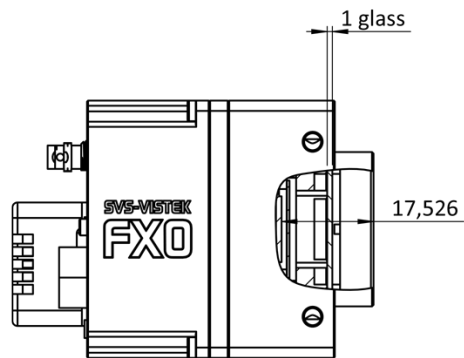

7.3 fxo990

front

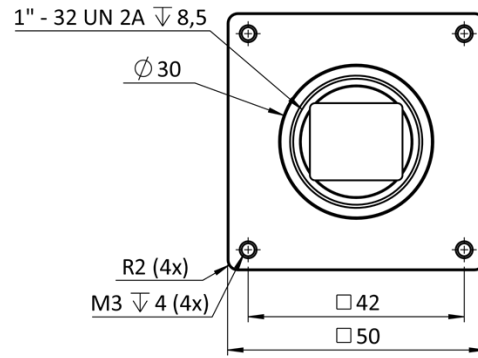

bottom

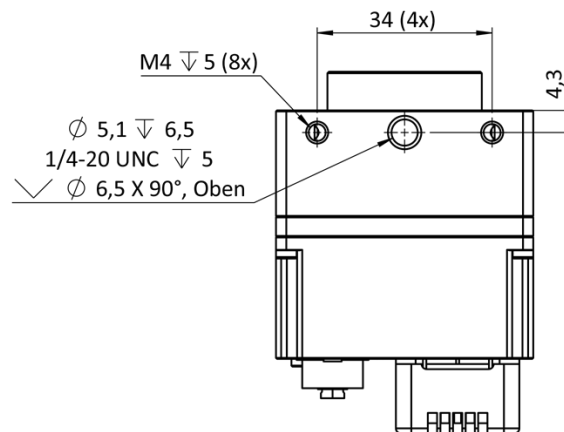

top

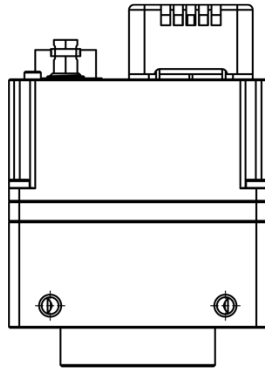

right side

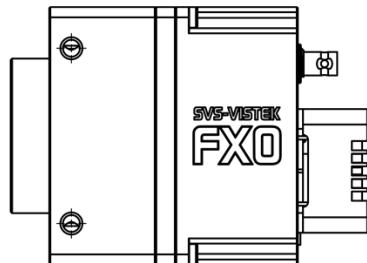

back

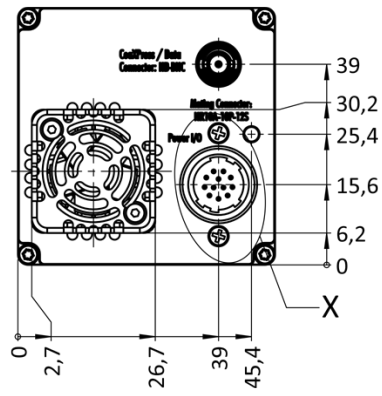

cross section

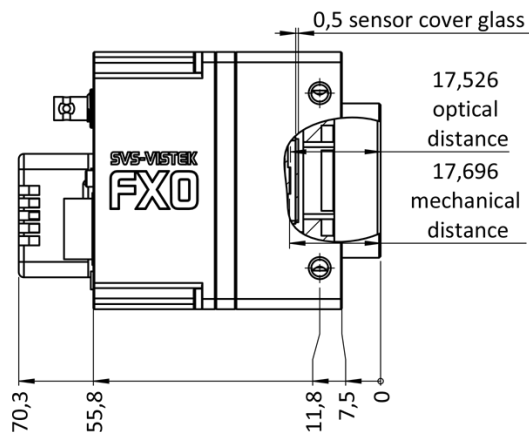

8 Appendix

8.1 I/O driver circuit schematics

Camera power supply and power supply for PWM out is 25V max. Power for PWM out has to be supplied via Hirose connector. The open drain outputs are ledged to ground, that means you connect your LED on the positive side to your (light-)power source, the negative LED connector goes to the camera out. This setup requires common ground.

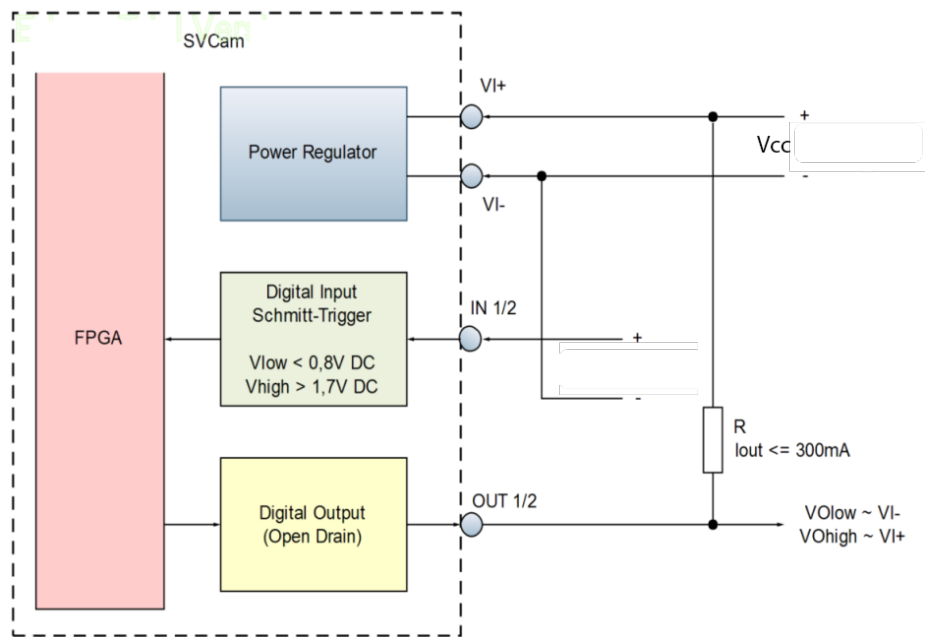

Fig.: 8-1: I/O driver circuit schematics

8.2 IP protection classes

IP Protection Classes is a classification system regarding the kind of environment influences which might do harm to your product.

First Digit	Second Digit	Brief description	Definition
0		Not protected	-
1		Protected against solid foreign objects, 50 mm and larger	A probing object, a ball of 50mm in diameter, must not enter or penetrate the enclosure
2		Protected against solid foreign objects, 12.5 mm and larger	A probing object, a ball of 12.5mm in diameter, must not enter or penetrate the enclosure
3		Protected against solid foreign objects, 2.5 mm and larger	A probing object, a ball of 2.5mm in diameter, must not penetrate at all
4		Protected against solid foreign objects, 1.0 mm and larger	A probing object, a ball of 1mm in diameter, must not penetrate at all
5		Protected against dust	The ingress of dust is not completely prevented. The quantity of dust that enters not impair the safety or satisfactory operation of the equipment
6		Dustproof	No ingress of dust
	0	Not protected against liquids	-
	1	Protected against water droplets	Vertically falling droplets must not have any harmful effect when the enclosure is at an angle of 15° either side of the vertical
	2	Protected against water droplets	Droplets falling vertically must not have any harmful effect with enclosure at an angle of 15° either side of the vertical
	3	Protected against spray water	Water sprayed at any angle of up to 60° either side of the vertical must not have any harmful effect
	4	Protected against water splashes	Water splashing against the enclosure from any angle must not have any harmful effect
	5	Protected against water jets	Water jets directed at the enclosure from any angle must not have any

First Digit	Second Digit	Brief description	Definition
			harmful effect
	6	Protected against powerful water jets	Powerful water jets directed against the enclosure from any angle must not have any harmful effect
	7	Protected against the effect of brief submersion in water	Water must not enter the equipment in amounts that can have a harmful effect if the enclosure is briefly submerged in water under standardised pressure and time conditions
	8	Protected against the effect of continuous submersion in water	Water must not enter the equipment in amounts that can have a harmful effect if the enclosure is continuously submerged in water.
			The conditions must be agreed between the manufacturer and the user. The conditions must, however, be more severe than code 7
	9K	Protected against water from high-pressure and steam jet cleaning	Water directed at the enclosure from any angle under high pressure must not have any harmful effect

SVS-VISTEK GmbH
Mühlbachstr. 20
82229 Seefeld
Phone: +49 (0) 81 52 9985-0
<https://www.svs-vistek.com>
info@svs-vistek.com

© June-2021